

# SELF CLEANING HOT TUBS OWNER'S MANUAL



**HYDROPOOL**  
hot tubs • swim spas



**HydroPool Inc.**  
**335 Superior Blvd.**  
**Mississauga, ON, Canada L5T 2L6**  
**Tel: 905.565.6810**  
**Toll Free: 1.800.465.2933**  
**Fax: 905.565.6820**  
**Email: [info@hydropoolhottubs.com](mailto:info@hydropoolhottubs.com)**  
**[www.hydropoolhottubs.com](http://www.hydropoolhottubs.com)**

**Contents subject to change without notice**

**BJAH**

# TABLE OF CONTENTS

<b>Letter of introduction</b>	3	Hydropool Surround Sound Audio	36
<b>Important User Safety Instructions</b>		INK800 Keypad Bluetooth Audio Functions	36
Warnings	4		
Hyperthermia	5	<b>Hot Tub Water Balance</b>	
<b>Choosing the Right location</b>		General Overview	37
Indoor Locations	6	Initial Fill	37
Outdoor Locations	6	Glossary of Common Water Maintenance Terms	38
<b>General Installation Considerations</b>	7	Water Balance Summary for your Hot Tub (chart)	38
		Water Balance Troubleshooting	39
<b>Special Considerations</b>		<b>Routine Hot Tub Maintenance</b>	
Indoor Installations	7	Daily, Weekly, Monthly, Quarterly	40
Outdoor Installations	7	Cleaning the Skimmer Basket	40
<b>Site Preparation</b>		Safety Hard Cover	40
Above Ground Installations	8	Cartridge Filter, Removal, Cleaning, Re-installation	41
In-ground & Partial In-ground Installations	8	Cleaning the Acrylic Surface	41
Overall Support (non-cabinet installations)	8	Changing your Hot Tub Water	42
<b>Equipment Accessibility &amp; Protection</b>	9	Draining your Hot Tub Water	42
<b>Remote Equipment Placement</b>	9	<b>Hydropool Exclusive Quick-Drain™</b>	43
<b>Unloading/Handling your Hot Tub</b>	9	<b>Self-Cleaning Mode Indicator</b>	43
<b>Important Electrical Safety Instructions</b>	10	<b>Wood/ Everlast Products</b>	
G.F.C.I./R.C.D. Application Guideline & Wire Size	10	Cabinet Wing-Locks	44
North America G.F.C.I. Installation Diagram	11	Protecting your Cabinet Wood/ Everlast Finish	44
Europe R.C.D. Installation Diagram	12	<b>Winterizing your Hydropool Hot Tub</b>	45
<b>Filling, Checking and Starting your Hot Tub</b>	13-14	<b>General Troubleshooting</b>	46
Pump Priming/Releasing an Air Lock	13-14	What to do in the event of	
<b>Hydropool Control Systems</b>	15-24	Power Fluctuations	46
IN.YE / IN.YT Spa Pack Series	15-22	Cold Weather Power Failure	46
I-Command 2 System (optional)	23	<b>Wiring Diagrams (in.ye / in.yt )</b>	47-52
Standby Mode / Drain Mode	34		
Hydrother Control / Wellness Package (optional)	34		
<b>Topside Panel Display Messages</b>	35		
<b>Optional Variable Air Therapy System</b>	35		

**NOTE: Product specifications, warnings and labels are subject to change without notice. This user's manual should be used as a guide only. For further information, please contact your independent Hydropool dealer.**

On behalf of everyone at the company, we thank you for your decision to purchase a HydroPool hot tub.

Recognized for quality worldwide, we are confident that your new hot tub will provide you, your family and friends, with years of enjoyment and fulfill all your hydrotherapy needs.

HydroPool hot tubs are not only healthful and relaxing, they can even add value to your home.

**Please take the time to carefully read and understand all the safety, installation and operating instructions in this manual before electrically connecting your hot tub and adding water.**

The following pages contain valuable information and pointers that will save you both time and money, as well as help you to simplify upkeep and maintenance.

Since we manufactured our first hot tub in 1985, the HydroPool team has been dedicated to producing a quality product catering to maximum hydrotherapy, comfort, energy efficiency and ease of operation.

We are confident that as you become more familiar with the various safety and maintenance features of your new hot tub you will be satisfied that you made the right decision in purchasing a HydroPool hot tub.

**Happy hot tubbing...**



**David Jackson**



## SAVE THESE INSTRUCTIONS

### IMPORTANT SAVE THESE INSTRUCTIONS

Your physiological response to hot water is subjective and depends on your age, health, and medical history. If you don't know your tolerance to hot water, or if you get a headache, or become dizzy or nauseous when using your hot tub, get out and cool off immediately.



# WARNING

1. CHILDREN SHOULD NOT USE SPAS OR HOT TUBS WITHOUT ADULT SUPERVISION.
2. DO NOT USE SPAS OR HOT TUBS UNLESS ALL SUCTION GUARDS ARE INSTALLED TO PREVENT BODY AND HAIR ENTRAPMENT.
3. PEOPLE USING MEDICATIONS AND/OR HAVING ANY ADVERSE MEDICAL HISTORY SHOULD CONSULT A PHYSICIAN BEFORE USING A SPA OR HOT TUB.
4. PEOPLE WITH INFECTIOUS DISEASES SHOULD NOT USE A SPA OR HOT TUB.
5. TO AVOID INJURY, EXERCISE CARE WHEN ENTERING OR EXITING THE SPA OR HOT TUB.
6. DO NOT USE DRUGS OR ALCOHOL BEFORE OR DURING THE USE OF A SPA OR HOT TUB, TO AVOID UNCONSCIOUSNESS AND POSSIBLE DROWNING.
7. PREGNANT OR POSSIBLE PREGNANT WOMEN SHOULD CONSULT A PHYSICIAN BEFORE USING A SPA OR HOT TUB.
8. WATER TEMPERATURE IN EXCESS OF 38°C (100°F) MAY BE INJURIOUS TO YOUR HEALTH.
9. BEFORE ENTERING THE SPA OR HOT TUB, MEASURE THE WATER TEMPERATURE WITH AN ACCURATE THERMOMETER.
10. DO NOT USE A SPA OR A HOT TUB IMMEDIATELY FOLLOWING STRENUOUS EXERCISE.
11. PROLONGED IMMERSION IN A SPA OR HOT TUB MAY BE INJURIOUS TO YOUR HEALTH.
12. DO NOT PERMIT OR USE ELECTRIC APPLIANCES (SUCH AS LIGHT, TELEPHONE, RADIO OR TELEVISION) WITHIN 1.5M (5FT) OF THIS SPA OR HOT TUB.
13. CHILDREN SHOULD NOT ENTER A HOT TUB WHERE THE WATER TEMPERATURE EXCEEDS BODY TEMPERATURE (37°C / 98.6°F).
14. DO NOT ALLOW CHILDREN TO SUBMERGE THEIR HEAD UNDER WATER.
15. NEVER OPERATE THE HOT TUB PUMP AT HIGH SPEED WITHOUT HAVING ALL SUCTION AND RETURN LINES OPEN.
16. ALWAYS KEEP THE HARDCOVER INSTALLED AND LOCKED WHEN THE HOT TUB IS NOT IN USE.
17. TEST THE GFCI (GROUND FAULT CIRCUIT INTERRUPTER) MONTHLY.
18. POST EMERGENCY PHONE NUMBERS FOR POLICE, FIRE DEPARTMENT, AND AMBULANCE AT THE NEAREST PHONE.
19. TO REDUCE THE RISK OF INJURY
  - THE WATER IN A SPA SHOULD NEVER EXCEED 40°C (104°F). WATER TEMPERATURES BETWEEN 38°C (100°F) AND 40°C (104°F) ARE CONSIDERED SAFE FOR A HEALTHY ADULT. LOWER WATER TEMPERATURES ARE RECOMMENDED FOR YOUNG CHILDREN AND WHEN SPA USE EXCEEDS 10 MINUTES.
  - SINCE EXCESSIVE WATER TEMPERATURES HAVE A HIGH POTENTIAL FOR CAUSING FETAL DAMAGE DURING THE EARLY MONTHS OF PREGNANCY, PREGNANT OR POSSIBLY PREGNANT WOMEN SHOULD LIMIT SPA WATER TEMPERATURES TO 38°C (100°F).
  - BEFORE ENTERING A SPA, THE USER SHALL MEASURE THE WATER TEMPERATURE SINCE THE TOLERANCE FOR WATER TEMPERATURE-REGULATING DEVICES VARIES.
  - THE USE OF ALCOHOL, DRUGS, OR MEDICATION BEFORE OR DURING SPA USE MAY LEAD TO UNCONSCIOUSNESS, WITH THE POSSIBILITY OF DROWNING.
  - OBESE PERSONS AND PERSONS WITH A HISTORY OF HEART DISEASE, LOW OR HIGH BLOOD PRESSURE, CIRCULATORY SYSTEM PROBLEMS OR DIABETES SHOULD CONSULT A PHYSICIAN BEFORE USING A SPA.
  - PERSONS USING MEDICATION SHOULD CONSULT A PHYSICIAN BEFORE USING A SPA SINCE SOME MEDICATION MAY INDUCE DROWSINESS WHILE OTHER MEDICATION MAY EFFECT HEART RATE, BLOOD PRESSURE AND CIRCULATION.

## SAVE THESE INSTRUCTIONS

### IMPORTANT SAVE THESE INSTRUCTIONS

Your physiological response to hot water is subjective and depends on your age, health, and medical history. If you don't know your tolerance to hot water, or if you get a headache, or become dizzy or nauseous when using your hot tub, get out and cool off immediately.



# CAUTION

1. MAINTAIN WATER CHEMISTRY IN ACCORDANCE WITH THE MANUFACTURER'S INSTRUCTIONS.



# DANGER

1. RISK OF ACCIDENTAL DROWNING. EXTREME CAUTION MUST BE EXERCISED TO PREVENT UNAUTHORIZED ACCESS BY CHILDREN. TO AVOID ACCIDENTS, ENSURE THAT CHILDREN CAN'T USE THE SPA UNLESS THEY ARE SUPERVISED AT ALL TIMES.
2. RISK OF INJURY. THE SUCTION FITTINGS IN THIS SPA ARE SIZED TO MATCH THE SPECIFIC WATER FLOW CREATED BY THE PUMP. SHOULD THE NEED ARISE TO REPLACE THE SUCTION FITTINGS OR THE PUMP, BE SURE THAT THE FLOW RATES ARE COMPATIBLE. NEVER OPERATE THE SPA IF THE SUCTION FITTINGS ARE BROKEN OR MISSING. NEVER REPLACE A SUCTION FITTING WITH ONE RATED LESS THAN THE FLOW RATE MARKED ON THE ORIGINAL SUCTION FITTING.
3. RISK OF ELECTRIC SHOCK. INSTALL AT LEAST 1.5M (5FT) FROM ALL METAL SURFACES. AS AN ALTERNATIVE, A SPA MAY BE INSTALLED WITHIN 1.5M (5FT) OF METAL SURFACES IF EACH METAL SURFACE IS PERMANENTLY CONNECTED BY A MINIMUM 8 AWG (8.4 mm<sup>2</sup>) SOLID COPPER CONDUCTOR TO THE WIRE CONNECTOR ON THE TERMINAL BOX THAT IS PROVIDED FOR THIS PURPOSE.
4. RISK OF ELECTRIC SHOCK. DO NOT PERMIT ANY APPLIANCE, SUCH AS A LIGHT, TELEPHONE, RADIO, OR TELEVISION, WITHIN 1.5M (5FT) OF THE SPA.

### HYPERTHERMIA

Since your hot tub can be set to reach temperatures of 40°C (104° F), users should be aware that extended submersion in water that exceeds normal body temperature can lead to hyperthermia.

The causes, symptoms and effects of hyperthermia may be described as follows:

Hyperthermia occurs when the internal temperature of the body reaches several degrees above the normal body temperature of 37°C (98.6°F). The symptoms of hyperthermia include drowsiness, lethargy, and an increase in the internal temperature of the body. The effects of hyperthermia include:

- Unawareness of impending hazard
- Failure to perceive heat
- Failure to recognize the need to exit the hot tub
- Physical inability to exit the hot tub
- Fetal damage in pregnant woman
- Unconsciousness resulting in the danger of drowning

If you sense any of the symptoms of hyperthermia, safely exit the hot tub immediately.

## WARNING



THE USE OF ALCOHOL, DRUGS OR MEDICATION CAN SIGNIFICANTLY INCREASE THE RISK OF FATAL HYPERTHERMIA.

## CHOOSING THE RIGHT LOCATION

Your HydroPool hot tub can be installed indoors or out, on the ground, in the ground or half-and-half. The following information will assist you in choosing the right location for your individual needs. When making your decision, always remember that hot tubs can be enjoyed year-round, indoors or out, regardless of the climate. Many HydroPool owners report that their favourite time to use a hot tub is in the cooler fall and winter months, while others praise the enjoyment of using their hot tub in the warmer spring and summer months.

### INDOOR LOCATIONS

If members of your family are not cold weather enthusiasts, or if your backyard or patio area is not suitable for a hot tub installation, then an indoor location for your hot tub may be your best or only choice. You may wish to create an exercise/spa area in your home, or install your hot tub in a glass solarium or four-season room adjoining your home. Indoor installations not only add a unique look and appeal to your home, they provide the privacy and controlled climate to ensure that use and enjoyment of your hot tub is maximized. If you should choose an indoor location, you will find further information as outlined in the section **“SPECIAL CONSIDERATIONS FOR INDOOR INSTALLATIONS”**



### OUTDOOR LOCATIONS

For a variety of reasons, outdoor locations are a far more popular choice. Some of the reasons include:

- Limited indoor space
- Delivery complications due to door openings, stairwells, etc.
- Limited budget (indoor installations usually also involve interior home renovations)
- Desire for an outdoor entertainment center
- Hot tub is being installed adjacent to an existing or planned swimming pool
- Concerns over splashing water inside the home

For those who choose an outdoor location, hot tub operating temperatures can be adjusted to match the season. In colder months, many owners will operate their hot tub in the range of 38-40°C (100 -104°F). During warmer months, an operating temperature of 36-37°C (97-99°F) will provide a refreshing retreat. If you should choose an outdoor location, you will find further information as outlined in the section **“SPECIAL CONSIDERATIONS FOR OUTDOOR INSTALLATIONS”**



## GENERAL INSTALLATION CONSIDERATIONS

- 1 Your HYDROPOOL hot tub is a self-contained pre-plumbed unit, so that no on-site plumbing connections to the residential water supply or drain are required.
- 2 Ensure that your HYDROPOOL hot tub is properly supported by either a level concrete pad, or a properly constructed deck capable of supporting 1220 kg/m<sup>2</sup> (250 lbs./ft.<sup>2</sup>). If there is a possibility that the pad could shift by freezing/thawing ground movement (such as in clay regions, and/or areas with high water tables) concrete footings extending below the frost line are recommended.
- 3 Decking should be chosen and constructed in a manner that minimizes the chance of slipping or falling.
- 4 If you do not have a factory installed insulated cabinet, it is assumed that you are building your own custom cabinet, tiling or decking.

**Please consider the following:**

- a Your HYDROPOOL hot tub is self-supporting on its base. The cabinet should be decorative only, not for support. Never suspend the hot tub from the deck or cabinet.
- b Where the hot tub is not equipped with a factory installed cabinet, it is the installer's responsibility to ensure all electrical equipment is **completely weather protected** and meets all of the regulatory requirements.

- c Always provide adequate access for servicing the support equipment.
  - d Decking should be constructed to allow repair access around the entire hot tub.
  - e In remote equipment or no-cabinet installations, you may add extra insulation, but the equipment area must have adequate cross-flow ventilation.
- 5 Installation of a safety grab rail or reachable support for use when entering or exiting the hot tub is recommended.
  - 6 A nearby garden hose connection is recommended for filling and "topping up" the hot tub.

### WARNING



The hot tub equipment and all electrical plugs, outlets and lights within 1.5m (5ft) of the hot tub must be G.F.C.I protected. Consult your electrician or local electrical authority for further details.

**Access to the hot tub must always be secured:**

**Outdoors - in accordance with local property by-laws and/or via an approved fence with a self-closing gate and a safety hardcover;**

**Indoors - by a lockable door and a safety hardcover.**

## SPECIAL CONSIDERATIONS

### INDOOR INSTALLATIONS

- It is beneficial to have the hot tub room located near washroom and shower facilities
- The hot tub room should have a floor drain to handle splash water, a window, outside exhaust fan or humidistat controlled exhaust fan for ventilation and a humidifier.
- Consider plumbing a water tap and drain location nearby to facilitate draining and top-up
- Always provide adequate ventilation for the support equipment
- Consult your local Hydropool retailer for further information

### OUTDOOR INSTALLATIONS

- Contact your local building code department to determine if a building permit is necessary and for information on applicable bylaws (distance from property lines, buildings, fencing requirements, etc.)
- If you are doing any excavating, contact your local gas, electric, and cable-company to ensure that there are no underground lines
- Locate the hot tub, where practical, within close distance of a door to the house to maximize potential winter use.
- Ensure that all hot tub support equipment is easily accessible and protected from the elements
- The hot tub support equipment is designed for indoor (out of the direct elements) use. When your HYDROPOOL hot tub is equipped with a factory-installed cabinet, and installed as per the guidelines of this manual, the equipment will be adequately protected. If the hot tub is shipped without a cabinet, your custom cabinet or other structure must be designed to supply protection for the hot tub support equipment from rain, snow, splash water, etc., but still designed in a manner to ensure adequate ventilation.

## SITE PREPARATION

### ABOVE-GROUND INSTALLATIONS

Where the hot tub is a “stand-alone” above-ground installation to be installed in regions where freeze/thaw conditions may occur, a level patio stone or pre-formed paver type base may be sufficient if there is no abutting deck(s) that could be damaged during potential seasonal movement of the ground. The potential drawback to this type of base is that splash water could eventually de-stabilize the ground under the base, with the resultant shift of the support base causing damage to the hot tub structure.

For best results, we recommend the installation of a level concrete pad:

- **Dig out and level the ground 20-30 cm (8-12 in.) below your desired base level**
- **Install 10-15 cm (4-6 in.) of crushed stone**
- **Next, install 10-15 cm (4-6 in.) of poured concrete**
- **Level the concrete and apply a broom-type finish**
- **We recommend that the pad be made 15 cm (6 in.) larger than the hot tub on three sides, and 1 m (3 ft.) larger on the side where the access steps and/or planters will be installed.**
- **Hot tub/swim spa must be installed on a level pad**

In regions where freeze/thaw occurs, or where there will be custom decking abutting the hot tub we recommend the installation of sono-tubes beneath the pad to prevent shifting.

### IN-GROUND & PARTIAL IN-GROUND INSTALLATIONS

For units being installed fully or partially in the ground, the type of support will again vary based on whether or not the tub is being installed in an area with freeze/thaw conditions. Hydro-pool does **not** recommend back-filling full in-ground or partial in-ground installations.

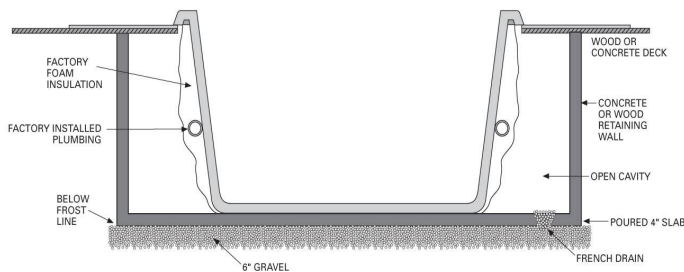

- Non-freezing climates – it is sufficient to ensure that the base of the hole or cavity created for the tub has a dry, stable, compacted level base and proper drainage.
  - Climates where freeze/thaw occurs – it is necessary that a poured level reinforced concrete base, complete with concrete footings, be installed as outlined in the section **ABOVE-GROUND INSTALLATIONS**.
- Areas with a high ground water table – a level concrete base, as well as a concrete or wood retaining wall to hold back the earth, is recommended. This forms a box or ‘bunker’, in which the hot tub is placed.
- **ALWAYS** ensure that there is good drainage, via a properly designed French drain (gravel) system and/or a sump pump, to prevent ground water flooding damage to the support equipment or hot tub structure.
  - Install protective waterproof conduit to house any cables that will be buried.
  - Access for future service must be considered at the time of design and installation. You must be able to access all sides and areas of your hot tub. Difficult access will result in supplemental service labor charges not covered by the factory warranty.
- Consider easily removable deck materials.
- Make sure the hot tub or swim spa is tested for 48 hours before you prepare the installation of the surrounding/finish deck around your hot tub. Even though all units are tested in our plant, some transport/site handling damage can occur and we suggest you make sure the tub is perfectly waterproof before finalizing your installation.

### OVERALL SUPPORT (non-cabinet installations)

Your Hydro-pool hot tub is equipped with a factory installed load support substructure, which distributes the weight of the water over the entire foot area of the hot tub. The cabinet, either factory installed or customized on-site, should be decorative only, and not relied on for overall support. Although the lip of the hot tub must be supported to ensure it remains level, never suspend a hot tub from a deck or floor by the outer acrylic edge, as this will lead to product damage and/or serious personal injury.

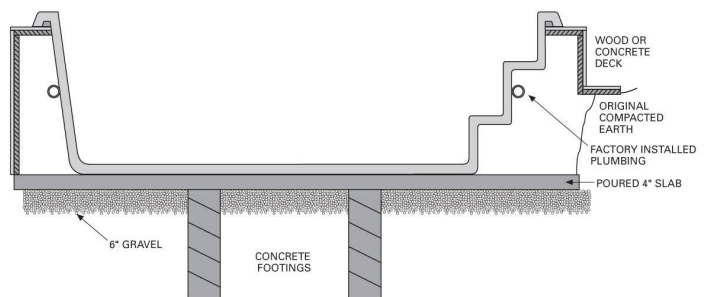



## EQUIPMENT ACCESSIBILITY AND PROTECTION

The equipment must be located in an area where it will remain serviceable, dry and will not be exposed to rain, snow or ground water.

### REMOTE EQUIPMENT PLACEMENT

The pump(s) and control with heater must be installed below water level to ensure priming and maximize performance.

- The equipment should be located as close to the hot tub as possible to maximize jet performance.
- Where you have ordered your hot tub with optional remote equipment, ensure that the equipment is not located more than 3 m. (10 ft.) from the hot tub.
- Use only equivalent size flex-pipe for the pipe runs from the equipment to the hot tub, with minimal use of elbows or other pipe restrictions.
- Install protective waterproof conduit to house applicable cords or line extensions such as the sensor and top-side control cables, light wires or ozone tubing.
- In climates where freeze / thaw occurs we recommend that remote plumbing lines be buried below the frost line and that pipe insulation is applied over all pipes that run from the hot tub to the remote equipment to help maintain energy efficiency.

## UNLOADING / HANDLING YOUR HOT TUB

All HydroPool hot tubs are shipped with a protective combination layer of foam wrap, cardboard and plastic film. Each hot tub is factory strapped onto a wood skid. If your hot tub is to be delivered by your local dealer, it will generally arrive on a flat bed truck or low profile trailer. Most dealers are equipped with the necessary equipment to maneuver the hot tub from the truck to the dolly or cart that will be used to move your hot tub to the installation location.

Should your hot tub arrive in a common closed box trailer, it may be necessary to arrange with a local towing company for a tilt and load tow truck, with a pulley winch system, to pull the skid from the larger trailer to the lower profile tow truck flat bed. The hot tub can be gently slid off the low profile trailer and positioned on its side on a cart or dolly on its back side only.

Most HydroPool models require a clearance width of at least 100 cm. (39 in.) to allow movement of the unit on its side through alley-ways, fence openings, etc. Where this is not possible, the use of a crane to lift the hot tub from the truck or trailer over the house to the patio or yard is often a simple and economical option.



### WARNING

- **Do not move or place the hot tub on the side where the equipment is located as damage could occur**
- **Never roll or flip the hot tub end over end as the cabinet could be damaged**
- **Never lift or handle the hot tub by the plumbing**
- **Make sure that there is sufficient assistance to gently slide the hot tub off the dolly or cart to the support base without any damage**

**Important Note:** Damage caused during transportation or by improper handling is not covered by the factory warranty.

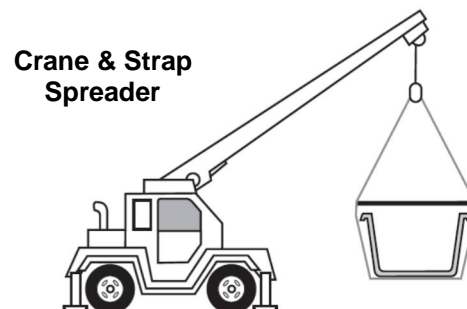
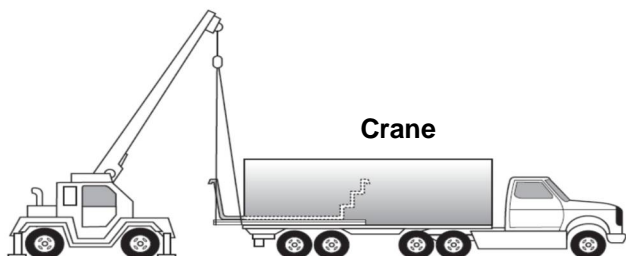

## IMPORTANT ELECTRICAL SAFETY INSTRUCTIONS

**SAFETY COMES FIRST. WHEN INSTALLING & USING THIS ELECTRICAL EQUIPMENT, BASIC SAFETY PRECAUTIONS MUST ALWAYS BE FOLLOWED!**

### 1 READ AND FOLLOW ALL INSTRUCTIONS

- 2 Electrical installation must be completed by a qualified electrician in accordance with all National, Regional and Local Codes and Regulations in effect at the time of installation.
- 3 Connect only to a dedicated circuit protected by a class 'A' two-pole ground fault circuit interrupter (GFCI)
- 4 **Use copper conductors only!**
- 5 The hot tub equipment and all electrical plugs, outlets and lights within 1.5m (5ft) of the unit must be G.F.C.I protected. Consult your electrician or local electrical authority for further details.
- 6 A green colored terminal or a terminal marked "G", "GR", "Ground", or "Grounding" is located inside the supply terminal box or compartment. To reduce the risk of electric shock, this terminal must be connected to the grounding means provided in the electric supply service panel with a continuous copper wire equivalent in size to the circuit conductors supplying the equipment.
- 7 At least two lugs marked "**BONDING LUGS**" are provided on the external surface or on the inside of the supply terminal box or compartment. To reduce the risk of electric shock, connect the local common bonding grid in the area of the hot tub to these terminals with an insulated or bare copper conductor not smaller than No.6 AWG (Canada/Europe) / No.8 AWG (USA).
- 8 All field installed metal components such as rails, ladders, drains or other similar hardware within 3 m (10 ft) of the hot tub shall be bonded to the equipment grounding bus with copper conductors not smaller than No.6 AWG.

### IMPORTANT NOTE: (FIGURE 1)

The following dimensions can be used to determine the proper location of submerged conduits in concrete slab installations. The dimensions are made from the outside of the spa / hot tub frame with the access for panels removed. The topside control panel is shown at the bottom of the diagram as a reference.

### WIRE SIZE

#### NORTH AMERICA

- The minimum wire size for systems that require a 40A GFCI is # 8/3 c/w ground (also referred to as # 8 gauge / 4 conductor).
- The minimum wire size for systems that require a 50A GFCI is # 8/3 c/w ground (also referred to as # 8 gauge / 4 conductor).

#### EUROPE

Standards for amperage breakers may vary from country to country in the CE controlled area. Please consult your local installer for advice on breaker level and wire specifications. Some examples are below:

- Breaker of 13A—wire must be 1.5 mm<sup>2</sup>
- Breaker of 16A—wire must be 2.5 mm<sup>2</sup>
- Breaker of 20A—wire must be 4.0 mm<sup>2</sup>
- Breaker of 32A—wire must be 6.0 mm<sup>2</sup>

**NOTE: Please consult your applicable electrical codes related to the size of conductors as they may vary from what is stated above. Take into consideration the length of cable as well and increase as required.**

### IMPORTANT NOTE:

- This guide is for standard installations where the wire run is 15 m (50 ft.) or less. For longer wire runs, consult a qualified electrician.

### G.F.C.I./R.C.D. APPLICATION GUIDE FOR HYDROPOOL SELF CLEAN SERIES

<b>NORTH AMERICA</b>	
<b>Gold Series</b>	40A
<b>Platinum Series</b>	50A
<b>Titanium Series</b>	60A
<b>EUROPE</b>	
<b>Gold Series</b>	20A
<b>Platinum Series</b>	20A
<b>Titanium Series</b>	40A

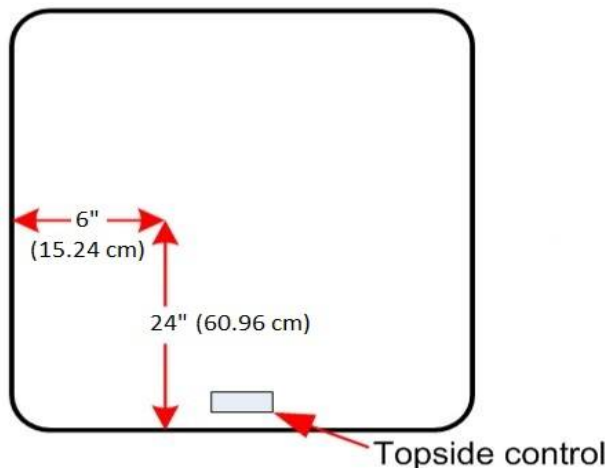

**FIGURE 1: ELECTRICAL CONDUIT LOCATION**

## NORTH AMERICA – GFCI INSTALLATION



Installation of the GFCI - Circuit Breaker, including ampere sizing and selection of conductor size and type, must be performed by a qualified electrician in accordance with the National Electrical Code, or the Canadian Electrical Code, and all Federal, State/Provincial and local codes and regulations in effect at the time of installation. HydroPool highly recommends the use of a new Siemens GFCI breaker for all of its products. Other GFCI's and older Siemen's GFCI's may have tripping issues.

### 240 VOLT 60Hz GFCI WIRING

Electrical wiring: North American model in.ye and in.yt

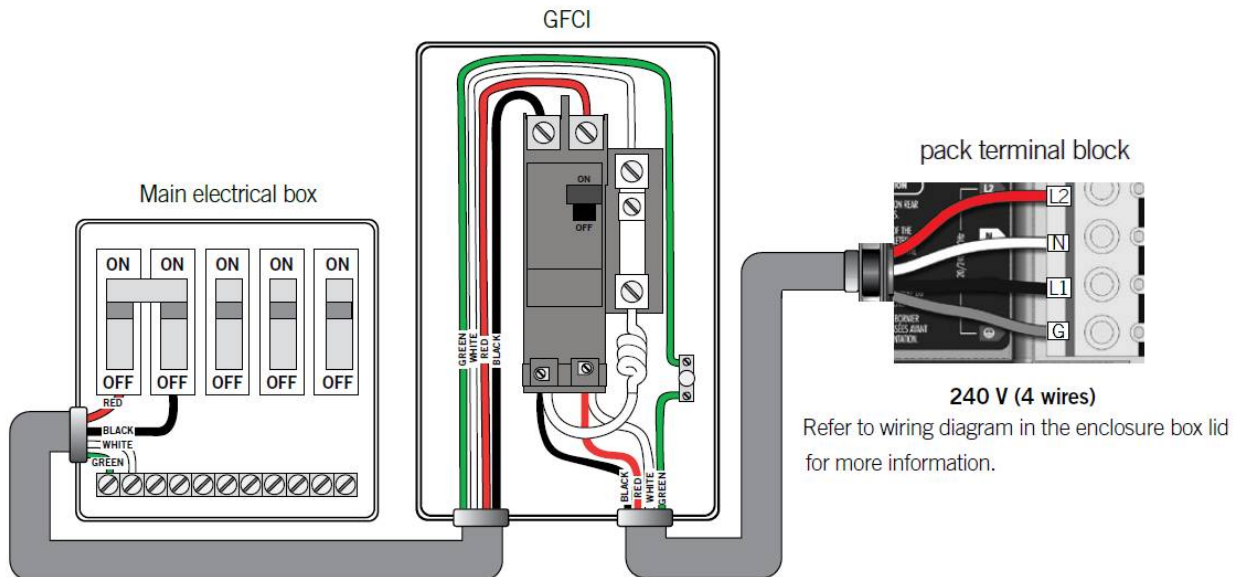

## EUROPE – R.C.D. INSTALLATION - TYPICAL



**Important Note:** Installation of the R.C.D. - Circuit Breaker, including ampere sizing and selection of conductor size and type, must be performed by a qualified electrician in accordance with National, Regional and Local Codes and Regulations in effect at the time of installation.

### 230 VOLT 50 Hz SINGLE PHASE RCD WIRING

#### Electrical wiring: European model in.ye – in.yt

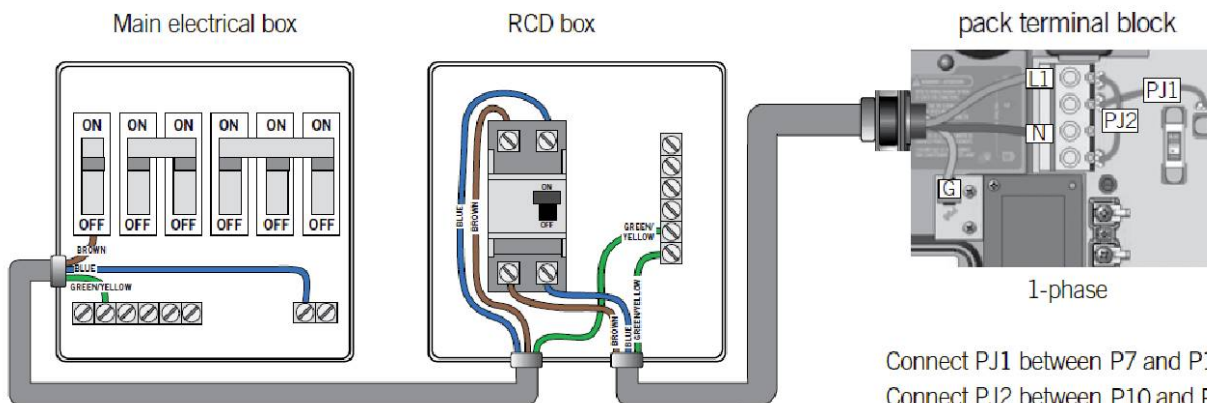

Connect PJ1 between P7 and P13.  
Connect PJ2 between P10 and P74.

### 230 VOLT 50 Hz DUAL PHASE RCD WIRING

#### Electrical wiring: European model in.ye – in.yt

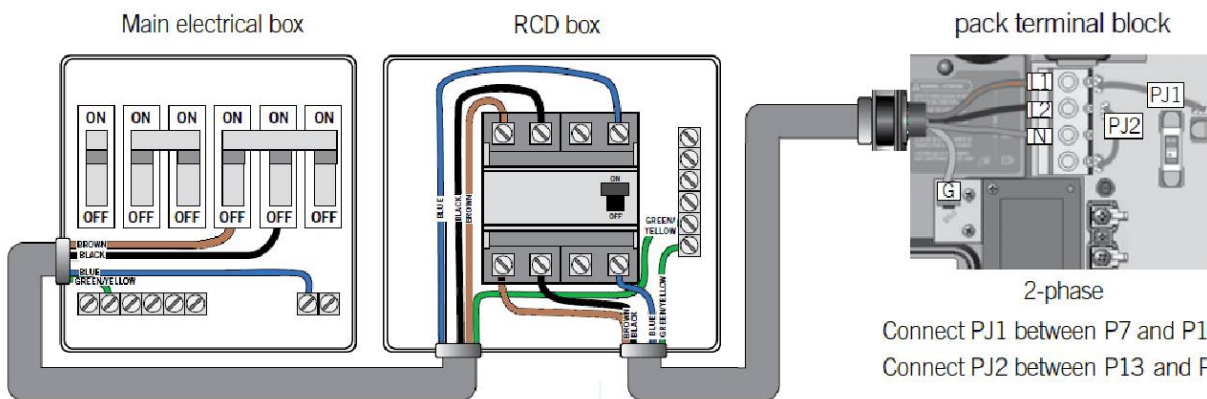

Connect PJ1 between P7 and P10.  
Connect PJ2 between P13 and P74.

### 230 VOLT 50 Hz THREE PHASE RCD WIRING

#### Electrical wiring: European model in.ye – in.yt

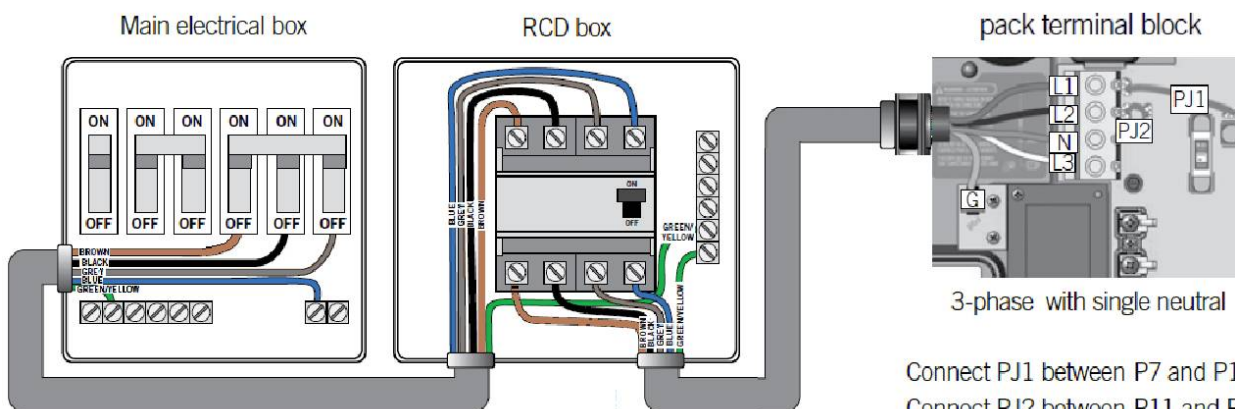

Connect PJ1 between P7 and P10.  
Connect PJ2 between P11 and P13.

## FILLING, CHECKING AND STARTING YOUR HOT TUB

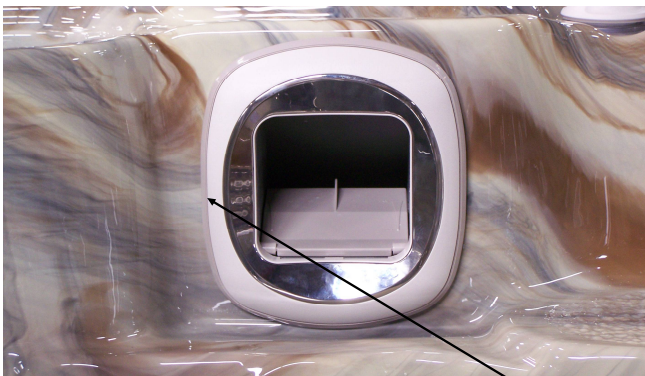
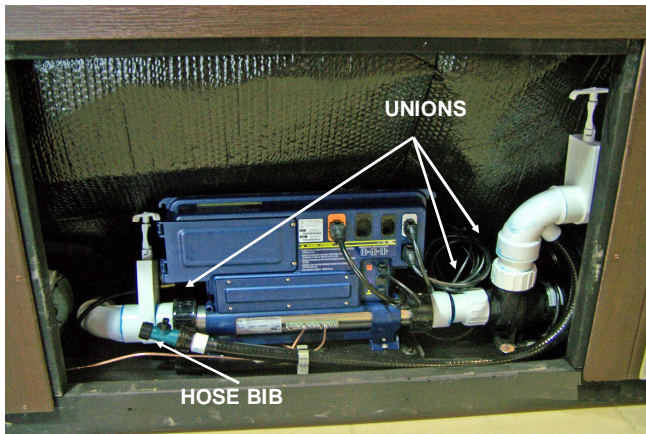
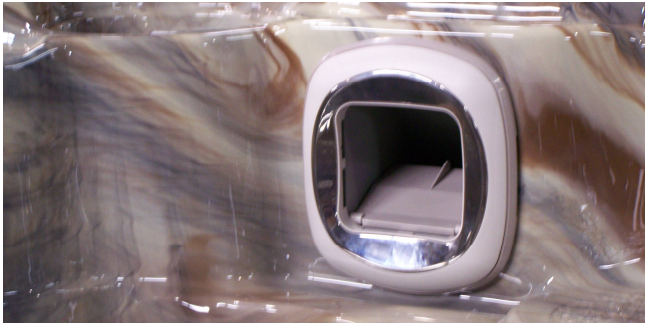

**PROPER WATER LEVEL**

### FILLING

When adding water for the first time, the hot tub should be filled through the skimmer opening (helps to prevent air locks) using a standard garden hose, turning the tap on slowly to prevent damage to the surface by a jerking hose connection.

- Pull up the handles on the intake and return gate valves and clip on the stem locks. (handles are pulled up when valves are open and pushed down when valves are closed).
- Ensure the drain hose-bib is closed.
- Ensure that all jets are open.
- Fill the hot tub to the recommended level as indicated by the "MIN" and "MAX" marks on the weir door of the skimmer opening.

### CHECKING

Although your hot tub was thoroughly water-tested in the factory, some loosening of fittings can occur during shipping. Before any decking, tiling or carpeting is completed around the installation, fill and operate your hot tub to test for leaks (this ensures easy access and inexpensive correction). Check all union connections and plumbing for minor leaks. In the event of a leak, ensure all union connections and pump plugs are tight and all o-rings/gaskets are in place.

### STARTING

Before applying voltage to power-up your hot tub, it is very important that you understand the sequence of events that occur when the system is activated in order that the pump can be primed efficiently and damage to the system can be avoided.

- Turn the main power "on" at your electrical panel.
- Follow the control instructions for your particular model hot tub to put the pump into low speed.

**See section HYDROPOOL CONTROL SYSTEMS**

### PUMP PRIMING/RELEASING AN AIR LOCK

On some systems a message will appear on the display indicating that the system is in **PUMP PRIMING MODE**.

This mode will last for 4 to 5 minutes before automatically entering the normal operation mode. **See complete details for your spa in section HYDROPOOL CONTROL SYSTEMS**

When the hot tub pump is located below water level, the water should start circulating immediately. If the motor works but if you do not notice water circulation within the first 15 seconds, the pump may require priming due to trapped air (referred to as an 'air lock'). To prime (inset 2), open the hose-bib to allow trapped air to escape. Close as soon as the water flow from the jets becomes regular. If the pumps have not primed after 2 minutes, and water is not flowing from the jets, **DO NOT** allow the pumps to continue to run. Turn power off at the main house panel (or GFCI) and try releasing the air again by loosening the union on the discharge side of the pump(s) while the motor is not running. Turn the power back on. If the pump(s) does not prime after 15 seconds, sometimes momentarily turning the pump(s) off and on will help the system to prime (note: do not do this more than 5 times). Repeat if necessary.

- **Important:** Under NO circumstances should the pump (s) be allowed to operate without priming beyond 5 minutes, as this may not only cause unwarrantable damage to the pump, it may also cause the control system to go into an overheat condition.

**Definition:** 'Priming' a pump is a term used to describe the process in which air trapped in the plumbing and pump wetend (referred to as an 'air lock') is released, allowing the pump to move water efficiently through the plumbing system and to the jets.

## RELEASING AIR TRAPPED IN FILTER...

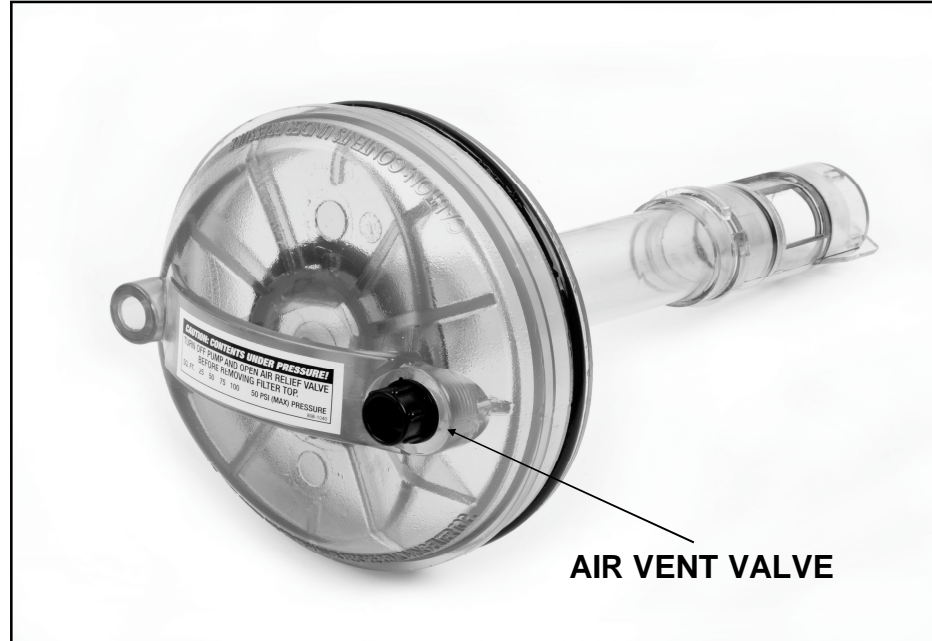

- When the pump starts circulating, it will be necessary to release trapped air in the filter. Carefully loosen the air vent valve counter-clockwise until there is the hissing sound of air escaping. Once there is a steady stream of water, close the vent valve, ensuring that the o-ring does not become pinched.
- Turn the Hydrotherapy pump(s) on and re-check for leaks. The control system will automatically return the pump(s) off after 15 minutes.
- Adjust the hot tub heat control at the topside panel to the desired water temperature.
- Adjust water balance (pH, TA, calcium hardness) to recommended levels and add sanitizer once the water temperature reaches 20°C (68°F).

### See section HOT TUB WATER BALANCE

- Keep insulated safety hard cover on the hot tub, and the air controls closed during the entire heat up process.

### NOTE:

**In order to prevent damage to your pillows caused by the gassing effect of the chemicals, we do recommend to remove them when the spa is not in use. By removing them you will extend considerably the life length of your pillows. We do design ours pillows to be removed easily in order to make sure they will not remain in the spa when it's not in use.**

HYDROPOOL SELF CLEAN SERIES CONTROL SYSTEMS NORTH AMERICA / EUROPE GECKO IN.YE/YT



www.geckoalliance.com

**INITIAL START-UP**

Before applying voltage to power-up your hot tub, it is very important that you understand the sequence of events that occur when the system is activated in order that the pump(s) can be primed efficiently and damage to the system can be avoided.

At initial power-up, the system will show the following screen.



The keypad does store the date and time for a limited time so when the system starts up after a loss of power it may be necessary to reprogram the time and date if the power down duration is greater than 48 hours.



**PROGRAMMING THE DATE AND TIME**

Here you can adjust the time format (AM/PM or 24h), day of the week and time. Use the arrows to choose the setting that you want to adjust and select it by pressing the Light key. Use the arrow buttons to change the parameters and the Light key to move between parameters. Pump 1 will take you back to the main Settings menu.



**TEMPERATURE CONTROL  
FUNCTIONALITY AND  
ADJUSTMENT**

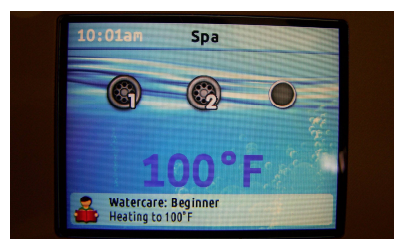

After you exit the programming mode your hot tub will automatically heat to the factory preset default temperature of 38°C (100°F).

The temperature shown in white on the screen is the current water temperature. Use the UP and DOWN buttons to set the desired temperature.

The set point will appear in the blue on the screen. After 3 seconds without any change to the set temperature value, the keypad will resume the normal display of messages.

When the set value is lower than the current temperature “Cooling to XX”F (°C)” will appear. When the value is set higher than the current temperature, “Heating to XX”F (°C)” will be indicated.

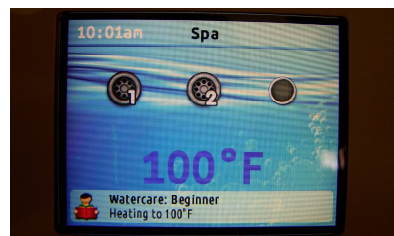

HYDROPOOL SELF CLEAN SERIES CONTROL SYSTEMS  
NORTH AMERICA / EUROPE  
GECKO IN.YE-3 GOLD CONTROLS



KEYPAD FUNCTIONS AND DISPLAY ICONS



SETTINGS KEY



MODE KEY



JET 1 KEY WHICH  
CONTROLS PUMP 1



SELECT KEY



SELECT KEY



SELECT KEY



BLOWER SELECT  
KEY



LIGHT KEY WHICH  
CONTROLS THE  
LIGHTING

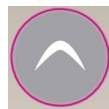

TEMPERATURE UP  
KEY



TEMPERATURE  
DOWN KEY



**HYDROPOOL SELF CLEAN SERIES CONTROL SYSTEMS**  
**NORTH AMERICA / EUROPE**  
**GECKO IN.YE-5 PLATINUM CONTROLS**



**KEYPAD FUNCTIONS AND DISPLAY ICONS**



**SETTINGS KEY**



**MODE KEY**



**JET 1 KEY WHICH  
CONTROLS PUMP 1**



**JET 2 KEY WHICH  
CONTROLS PUMP 2**



**SELECT KEY**



**SELECT KEY**



**BLOWER SELECT**



**LIGHT KEY WHICH  
CONTROLS THE  
LIGHTING**



**TEMPERATURE UP  
KEY**



**TEMPERATURE  
DOWN KEY**

HYDROPOOL SELF CLEAN SERIES CONTROL SYSTEMS  
NORTH AMERICA / EUROPE

GECKO IN.YT-12 TITANIUM AND HYDROTHER CONTROLS



KEYPAD FUNCTIONS AND DISPLAY ICONS



SETTINGS KEY



MODE KEY



JET 1 KEY WHICH  
CONTROLS PUMP 1



JET 2 KEY WHICH  
CONTROLS PUMP 2



JET 3 KEY WHICH  
CONTROLS PUMP 3  
(when installed)



SELECT KEY



BLOWER SELECT  
KEY



LIGHT KEY WHICH  
CONTROLS THE  
LIGHTING



TEMPERATURE UP  
KEY



TEMPERATURE  
DOWN KEY

## PUMP 1 FUNCTION

Press this pad to activate the pump

- 1st press – low speed (**icon rotates slow**)
- 2nd press – high speed (**icon rotates fast**)
- 3rd press – turns off

## PUMP AUTOMATIC TIME-OUT

**High speed** – 15 minutes

**Low speed** – 15 minutes

## PUMP 2 & 3FUNCTION (if included)

Press this pad to activate the pump

- 1st press – high speed (**icon rotates fast**)
- 2nd press – turns off

## PUMP AUTOMATIC TIME-OUT

**High speed** – 15 minutes

## LIGHT FUNCTION

Press this pad to activate the light

- 1st press: rotating colours
- 2nd press: solid blue colour
- 3rd press: solid green colour
- 4th press: solid red colour

**Note:** Pressing the light key in intervals less than three seconds will scroll to the next colour. Once you have selected the colour another press will turn the light off.

## LIGHT AUTOMATIC TIME-OUT

## SETTINGS KEY

From the home page you can access the Settings, where you will find:

- Water Care
- Audio (optional)
- In. clear (optional)
- Maintenance
- Day & Time
- Keypad Settings
- Wi-Fi (optional)
- Miscellaneous
- Electrical Configuration
- About

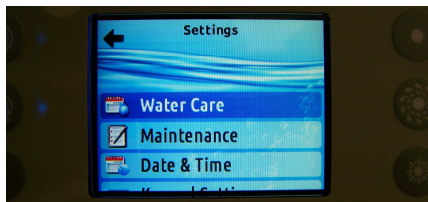

Use the arrow keys to move up and down in the list. To select an option, press the lit button beside it (Light button).

At any point you can press the Settings button to return to the home screen.



## WATER CARE

The Water Care section will help you set up your ideal filtration and heating settings. Choose from Away, Beginner, Energy Savings, Super Energy Savings and Weekender, depending on your needs.

Use the Light key to choose your setting. A checkmark will appear on the selected icon to confirm.

In Energy Savings mode, the set point will be reduced by 20°F (11°C), which means that the heating system will not be engaged unless the temperature falls to 20°F (11°C) below the spa's set temperature.

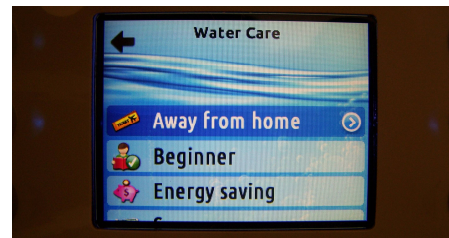

### Water Care Modes:

#### Away:

In this mode the spa will always be in economy; the set point will be reduced by 20°F (11°C) and the filtration can be reduced.

#### Beginner:

The spa will never be in economy mode, and will run a normal 24 hours of filtration a day.

#### Energy Savings:

The spa will be in economy mode during the peak hours of the day and resume normal mode on the weekend.

#### Super Energy Savings:

The spa will always be in economy mode during peak hours, every day of the week.

#### Weekender:

The spa will be in economy mode from Monday to Friday, and will run normally on the weekend.



## MODIFYING SCHEDULES

To see and / or modify the Water Care category, use the lit button to the right (Jet 1) to open the selected Water Care menu.

Use the arrow keys to choose a schedule to modify (choice of economy and filtration schedules). Use the Light key to move between parameters.

You have several possibilities for the schedule (Mon-Fri, weekend, every day, or single days). The schedules will be repeated every week. The time and duration are set in 30 minute increments. Once you have set the schedule, use Jet 1 key to go back. Ensure that you have selected the desired Water Care option in the main Water Care menu.

The filtration schedule shown on the screen will apply to the main filtration pump. Your spa uses a circulation pump configured to run 24 hours by default and the screen will show you the purge setting instead of filtration. The purges are pre-programmed for a fixed number of minutes, therefore the duration will be set to N/A on the screen, and only the start time can be modified.

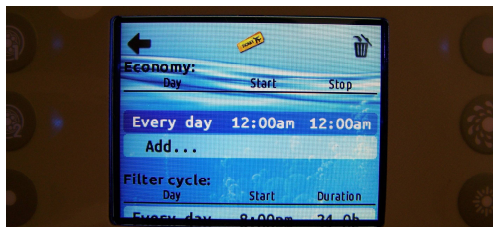
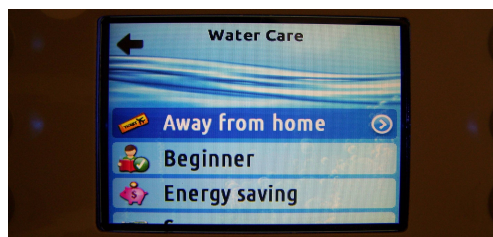

## FILTERING

Your spa is equipped with a circulation pump that filters your water for 24 hours a day. If the water temperature exceeds the set temperature by 4°F (and set point is 95°F or higher) then this pump will shut off automatically until the temperature drops below the set point by approximately 1.5°F.

You can bypass the pack filtration over-temperature feature. When Warm weather is "Off", the filtration over-temperature is disabled. This feature allows the spa to continue filtering even through the water temperature is high.

## AUDIO (optional)

The Audio section in the Settings menu gives you the option to disconnect or unpair your Bluetooth enabled device.



## IN.CLEAR (optional)

The in.k862 keypad can be used with the in. clear sanitization system. If you have ordered this option please refer to the separate instruction manual provided.



## MAINTENANCE

From the Settings page you can access the Maintenance Menu, which gives you access to the following options:

- Maintenance reminders
- Standby

Use the UP and DOWN keys to make a selection and Pump 2 to confirm the selection.



## MAINTENANCE REMINDERS

The in.k862 keypad will remind you of maintenance required on your spa, like rinsing or cleaning the filter. Each task has its own duration, based on normal use.

The Maintenance Reminders menu allows you to verify the time left before maintenance is required, as well as to reset the time once a task is completed.

Use the UP and DOWN keys to move through the list.

To reset a task, select it by pressing Pump 2, then confirm when prompted. Once you have confirmed the task will be reset.



## STANDBY

The Standby mode allows you to service your spa. Pumps will stop for 30 minutes, and automatically restart after this time.

Once Standby mode has been activated a screen will appear to show the pumps are stopped. The normal spa page will return at the end of the maintenance.

Press on the Confirm key to leave Standby mode and restart the spa.

## DATE AND TIME

Here you can adjust the time format, change the year, date and time. Use the arrows to choose the setting you want to adjust and select it by pressing Pump 2.

Use the arrow keys to change the parameters and Pump 2 to move between parameters. Pump 1 will take you back to the main Settings menu.



## KEYPAD SETTINGS

In this section you can change the temperature unit and language. Use the arrow keys and move to the setting that you would like to change. Use the Light key to choose and the arrow keys to modify

For the temperature setting you have a choice between Fahrenheit or Celsius.

For the language setting you have a choice between English and French.



### Wi-Fi (optional)

For the Wi-Fi menu to appear in the Settings menu your I-Command module must be equipped with software version 11.00 or higher. This menu allows you to connect your I-Command module to a Wi-Fi network or to change its network.

To connect your I-Command module to a wireless network, use the UP and DOWN keys to go to the Wi-Fi option in the Settings menu and Pump 2 to select it.

After a few seconds the available networks will appear on the screen, as well as their signal strength.

Use the UP and DOWN keys to move through the list. Select your network by pressing the Pump 2 key.

If the Wi-Fi network is password protected enter it when prompted. If no password is required it will connect automatically.

Once the in. touch module is connected to a Wi-Fi network a green check mark will appear in the Wi-Fi menu, and the network name will appear in the *Settings* menu.

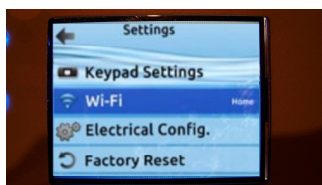

## ELECTRICAL CONFIGURATION

**Please do not make changes in this section unless you are a qualified electrician.**

### ABOUT

This section shows information about the keypad software number and the revision numbers of the different components of your system.

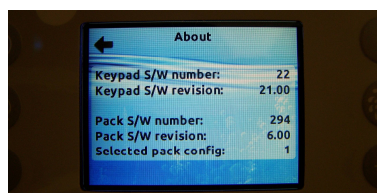

### PURGE CYCLES

The purge cycles are programmed to begin at the start of each filter cycle. Pump 2 activates for 1 minute, shuts off and then Pump 1 activates for 1 minute then shuts off.

### SMART WINTER MODE

Smart Winter Mode protects your system from the cold by turning the pumps on several times a day to prevent water from freezing in the pipes. The Smart Winter Mode indicator turns on when in this mode of operation. If the temperature drops to 4°C (39°F) within the heater chamber, the system automatically activates the pump to provide freeze protection. The pump will operate until the temperature reaches 5°C (41°F) before returning to normal system mode.

### COOLING DOWN

After heating the spa water to the desired set point, the heater is turned off, but the filtration pump remains on for a certain amount of time to ensure adequate cooling of the heating element in order to prolong the useful life of the heater. "Cooling to XX°F (°C)" message will appear at the bottom of the screen.

## OPTIONAL I-COMMAND 2 SYSTEM

The Smart Phone App that is designed as a wireless hot tub control which allows you to pick the water care settings that fit your schedule. Adjust filtration and temperature settings and create the ideal hot tub experience from inside your home. This option is supported by your iPhone®, iPod touch®, iPad® (requires iOS 8.0 or later) and Android Device (requires Android 2.3.3 and up).

**I-Command 2** (In. touch 2) comes with a state-of-the-art app and 2 pre-paired radio frequency transmitters:

One being part of the spa system and the second one, being connected to the Home Internet router. Both RF transmitters are pre-linked to one another, enabling an immediate and perfect communication between user and the spa.

### 1. Installing the home transmitter

The home transmitter is provided with an Ethernet cable and a power supply. The in. touch 2 home transmitter unit must be installed inside the house, connected to a router and powered by the provided wall transformer. A longer Ethernet cable may be used to bring the home transmitter closer to the spa.

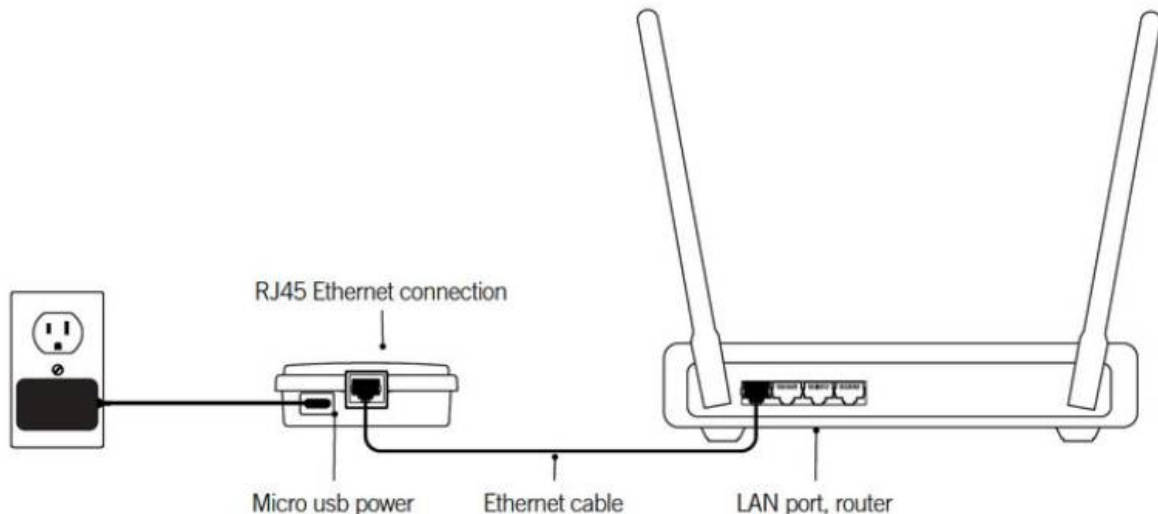

Simply connect the Ethernet cable into the RJ45 port of the in. touch 2 home transmitter and in one of the available LAN ports on your router. To power up the home transmitter, plug the provided wall outlet charger to a 120V (North American model) or 220V (European model) household supply and connect the USB cable to the wall outlet and the home transmitter.

## 2. Installing the spa transmitter

If you purchased a spa with in. touch 2 as a standard feature or as an option, note that the spa transmitter will be pre-installed. To ensure proper signal transmission, it may be necessary to change the position of the transmitter once the spa is installed in the yard. The transmitter should be located on the side of the spa facing the house.

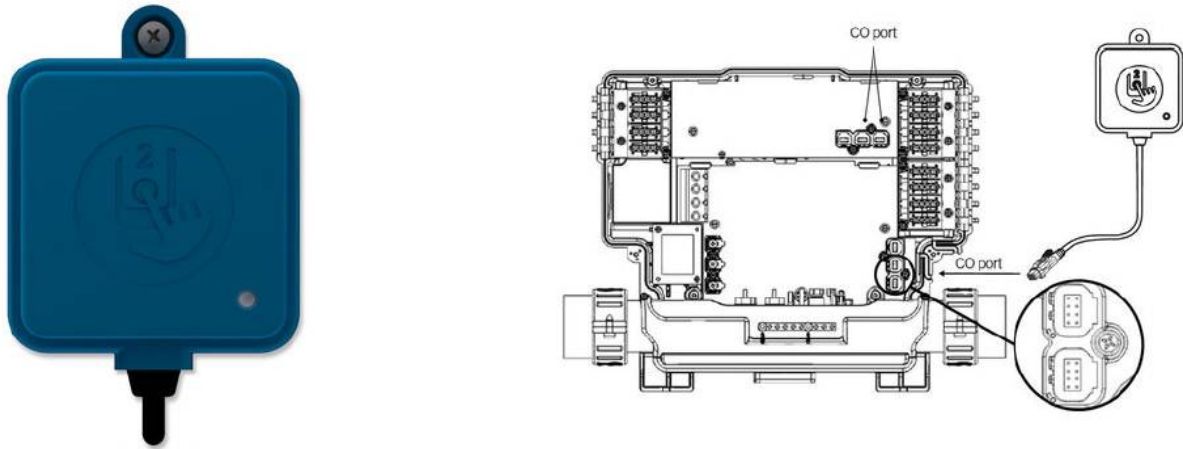

The in. touch 2 spa transmitter must be installed under the spa skirt, at least 12" (30 cm) away from any metal component or structure, as close as possible to the house to optimize the signal strength. Simply connect the spa transmitter into an available CO port of the spa control system (or any other accessory with a free CO port, such as the in. stream 2 audio amplifier, or the in. clear water sanitization system).

## 3. Pairing the home and spa transmitters

If you bought an in. touch 2 equipped spa or a complete retrofit kit, both transmitters of your in. touch 2 will be factory pre-paired.

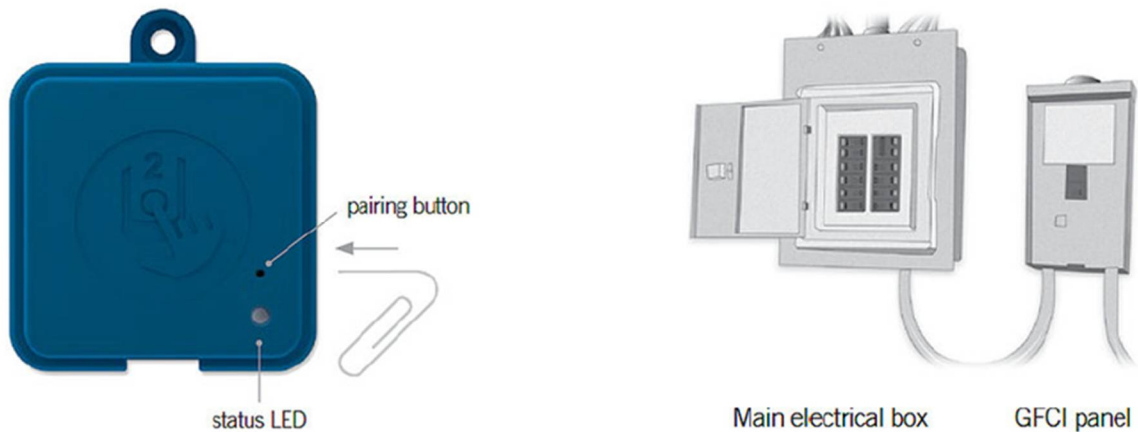



If you need to replace a transmitter or pair your transmitters again, power up the home transmitter and press on its pairing button with a paper clip. The status light of the transmitter will blink yellow.

Then, shut off the spa's breaker to turn the spa transmitter off. Wait a little and put the breaker back on. Within a few seconds, pairing will be completed and both transmitter status lights will turn to blue.

#### 4. Transmitters status LED indicator

Both the home and spa transmitters have color status LED that can be used for troubleshooting purposes



Home Transmitter	
Pairing mode	Yellow (Blinking)
Router not detected	Red
Router detected	Green
in.touch 2 server detected Module is fully functional	Blue

Spa Transmitter	
Pairing mode	Yellow (Blinking)
Spa controller not detected	Red
in.touch 2 server detected Module is fully functional	Blue

*When the LED status is blinking (blue, green or red) this indicates that the communication between the EN module and the CO module it not established.*

## 5. Strong and Long Range Communication Signal

Through their proprietary RF technology, in. touch 2 transmitters emit a strong, stable and long-range signal between your spa and your router (about 3 times longer than regular signal). No need for repeaters or boosters: your spa will always remain within reach in typical backyard settings.

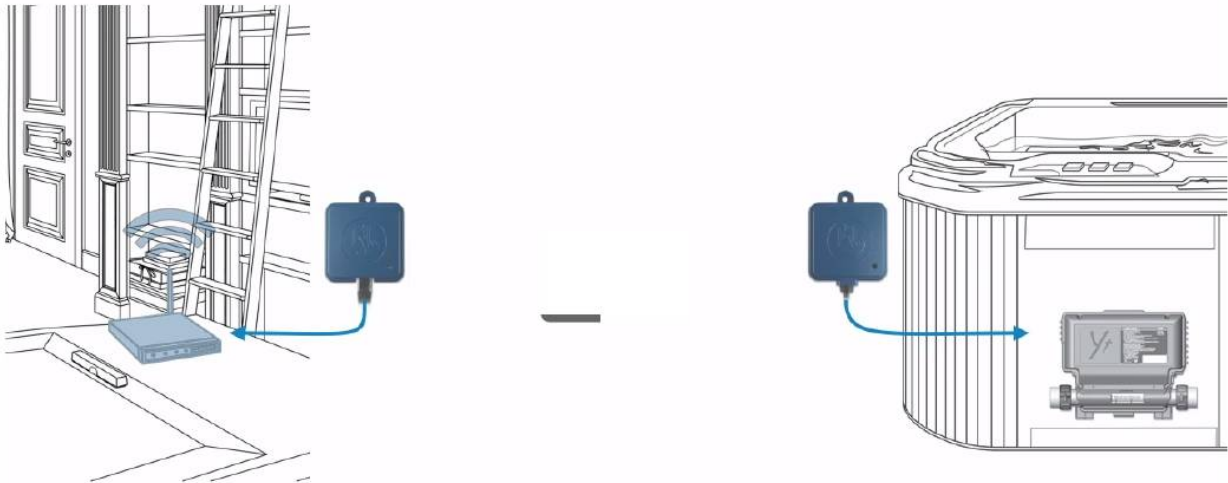

## 6. Application

Download application:



The in. touch app allows you to control your spa using your home network or an Internet connection anywhere in the world. The in. touch 2 app is waiting for you in the App Store for iOS devices and on Google Play for Android — search for « in. touch 2 » then click on it to install.

## USING THE APP

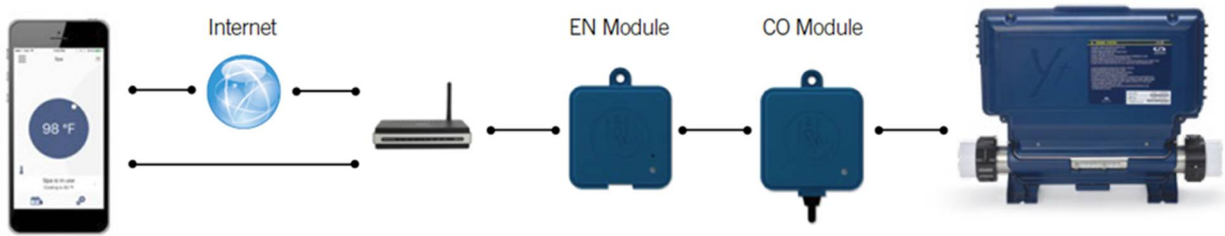

### On your home network

It is possible to access your spa with the in. touch 2 app through your home network. To be able to see your in. touch 2 in the application you need to connect your device to the same router (Wi-Fi network) than the one used to connect your Home Transmitter. Go to the Wi-Fi settings section of your mobile device and choose the same network that your spa is connected to (i.e. Home). Once you've selected it, wait until your device confirms the connection.

### On the Internet

The in. touch 2 allows you to use the Internet to control your spa from anywhere in the world. In order for them to communicate, both the in. touch 2 module and your device must be connected to a network that allows access to the Internet. Once your Home Transmitter is connected to the Internet (the LED status is blue), you can use your in. touch 2 app any time your device is also connected to the Internet (wireless or cellular network), even if you are away from home. To have access to your spa away from home, you will need to have previously linked your mobile device to your spa on your home network.

## Setup your Wi-Fi on your device

Before using your application, go to the Wi-Fi section of your device's settings. Make sure you are connected to your home network. This needs to be the same Wi-Fi provided by the router to which you connected your Home Transmitter.

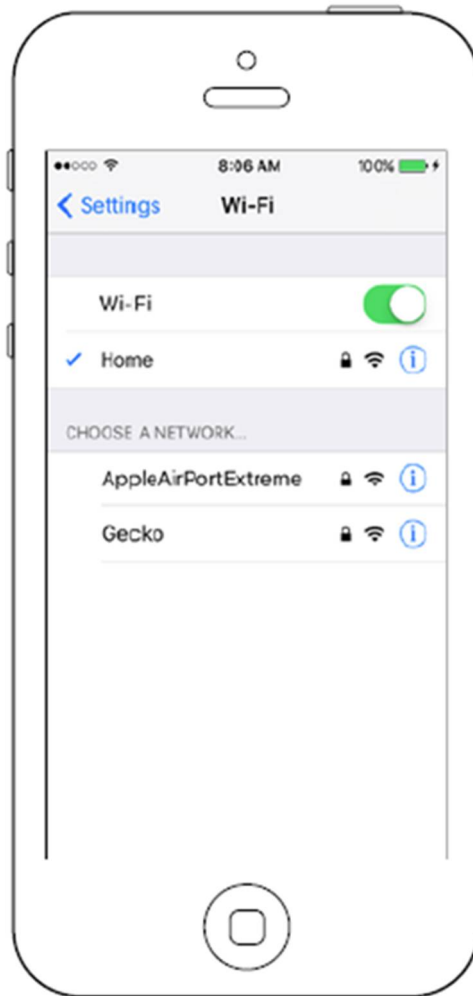



Find the icon for the in. touch 2 application, then tap on it to open it.

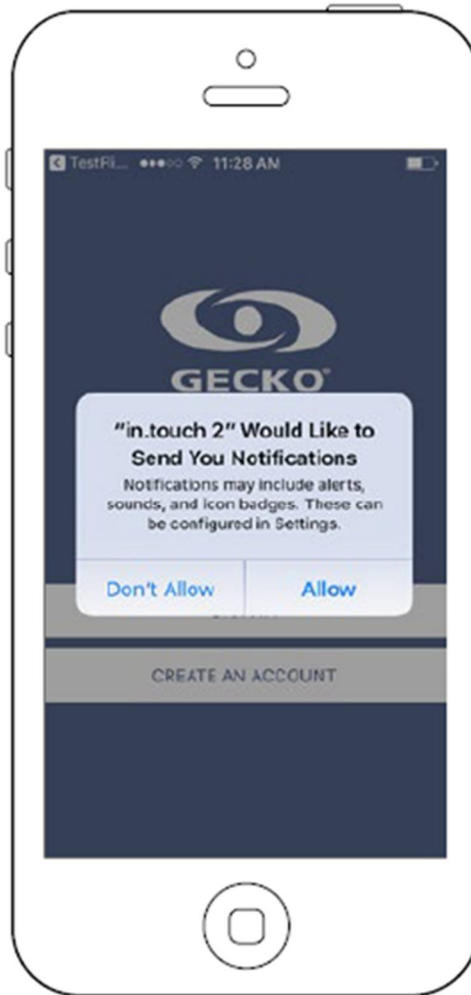

The first time you use the application a message will ask you: "in. touch 2" Would like to send you notifications. If you choose *Allow*, the application will send you notifications about the status of your spa. If you choose *Don't Allow*, the application will not send you notifications.

## Login page

Before using your application, you must create an account first and then, you'll be able to sign in. Your account will give you the opportunity to have access to your spa from any in. touch 2 application.



## New account creation

When you choose to create a new account, you agree at the same time the Terms of Service and the Privacy Policy. You can read them at any time through this link: <https://geckointouch.com/legal>

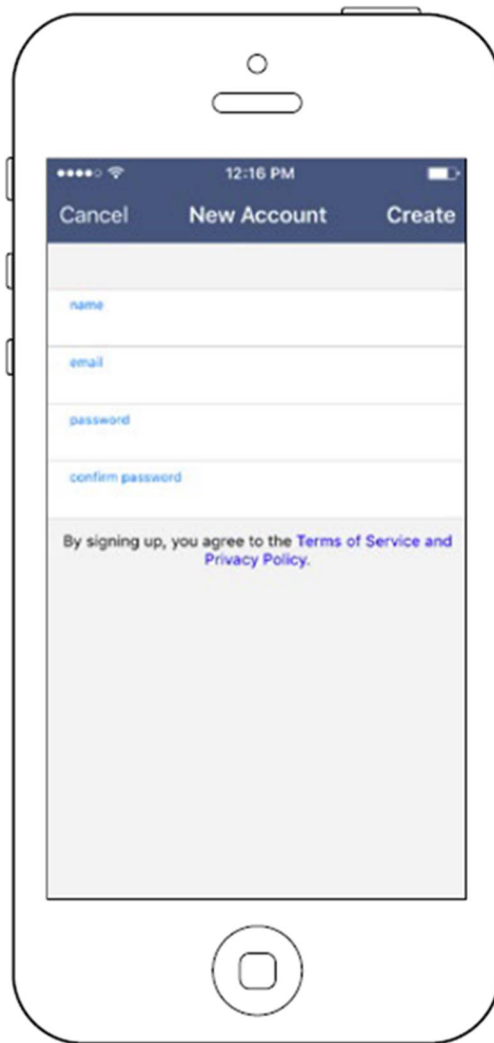

## Choose a spa



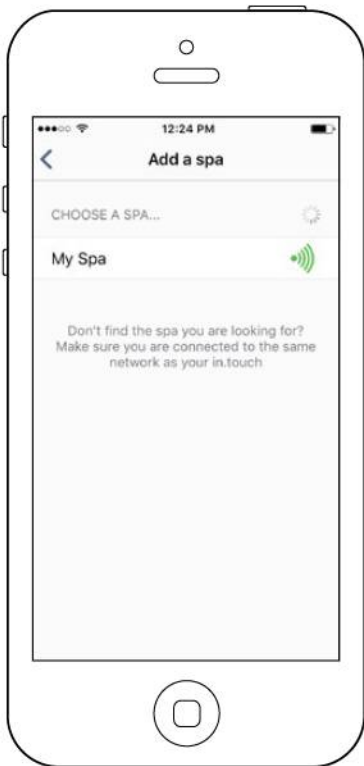

This page displays all the spas detected by your application.  
To detect your spa, you need to connect your mobile device to the same network to which you connected your Home Transmitter.

Once you have done a connection with the spa its name will be saved on this page to allow you to connect to this spa from anywhere.

To add a spa later on, go to Settings (up right corner) - Add a spa



The RF signal strength (communication between the two in.touch 2 transmitters) is illustrated on the Select a spa page. There are 5 possible states:

-  • Signal superior to 80%
-  • Signal between 80% and 51%
-  • Signal between 50% and 31%
-  • Signal below 30%
-  • The Spa Transmitter is not available



## Home page

The main screen gives you access to your accessories, water temperature, water care and settings.

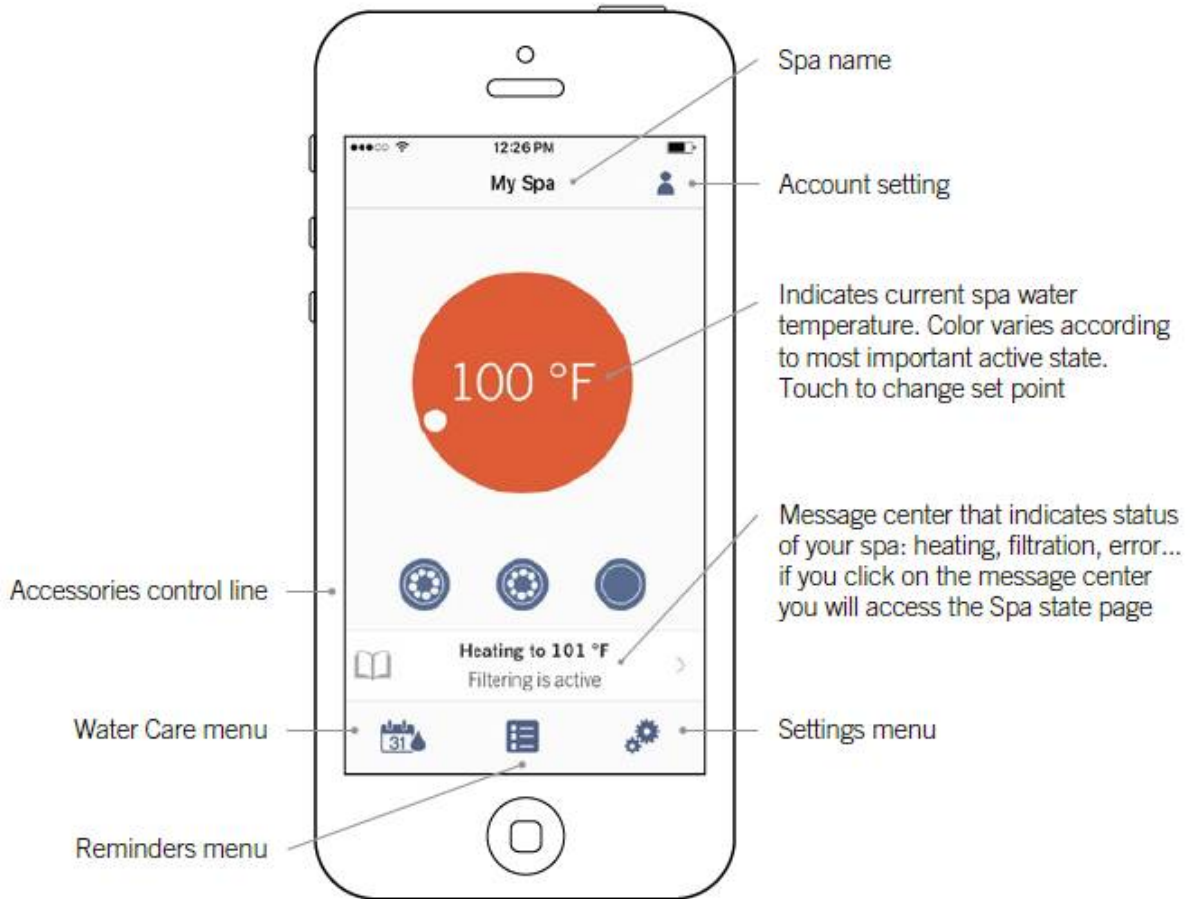

**The app is mirroring the top side control (keypad) over the internet.**

## STANDBY MODE



A press of the **SETTINGS** key brings you into the menu options. Use the **UP** and **DOWN** arrow keys to highlight **STANDBY**. Press the **LIGHT** key and the following message will appear.

“All pumps off! Press Drain to drain spa”

This mode allows you to stop all outputs including all automatic functions such as a filter cycle, heating requests and smart winter mode purging for 30 minutes to perform quick spa maintenance.

## DRAIN MODE

If you wish to put your spa into “**DRAIN MODE**” press the **FUNCTION** key beside the word “**Drain**” on the display. Once you do that the display will indicate “**Drain in progress**”. The filtration pump will turn on and run for 60 minutes.

In order to exit this mode, press the **FUNCTION** key beside the back arrow once to exit **DRAIN MODE**. This will put you back into **STANDBY MODE** and if you wish to exit that press the same key to go back to the main screen.

## HYDROTHER CONTROL AND WELLNESS THERAPY PACKAGE

This optional feature allows you to select from eight different therapy packages to help soothe your aches and pains or focus on key parts of your body that need some attention. In order to select the therapy you are looking for please reference the “Wellness Guide” that came with your hot tub and follow the instructions below.

## PROGRAMMING THE HYDROTHER / WELLNESS THERAPY

From the main display page, press the **MODE** key to navigate into the submenu. Press the **FUNCTION** key beside the **THERAPY** mode. From there you will see the first selection page which offers your four optional therapy packages (**LEG, BACK, DIET+, SPORT+**). If you wish to select one of these packages simply press the **FUNCTION** key beside the therapy you are looking for. If not, press the **NEXT** key to go to the second page which offers you another four optional therapy package (**HEADACHE, INSOMNIA, STRESS, TONIC**). Press the **FUNCTION** key beside the therapy you are looking for a relax.

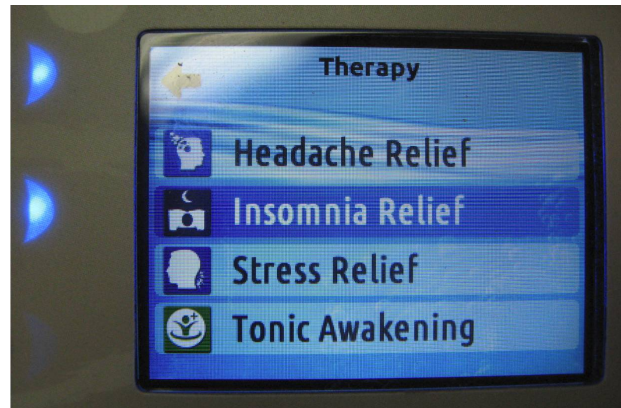

## TOPSIDE PANEL DISPLAY MESSAGES

**Hr** - An internal hardware error has been detected

**Prr** - The Prr error message indicates a problem with the regulation probe. The system is constantly verifying if the temperature probe reading is within its normal limits.

**HL** - The water temperature at the heater has reached 119°F (48°C). **Do not enter spa water.**

**FLO** - The system did not detect any water flow while the filtration pump was running.

**UPL** - No low level configuration software has been downloaded into the system.

**AOH** - The temperature inside the spa skirt is too high, causing the internal temperature in the spa pack to increase above the normal limits.

**OH** - The water temperature in the spa has reached 108°F (42°C). **Do not enter spa water.**

### OPTIONAL VARIABLE AIR THERAPY SYSTEM CONTROL FUNCTIONS:

**Press:** Blower button on main control to activate system.

**1) ON/OFF :**

**1<sup>st</sup> Press:** The Blower starts at maximum Speed. LED: ON

**2<sup>nd</sup> Press:** The blower stops. LED: OFF

**2) TO CONTROL SPEED:**

**Press and hold:** Speed goes up or down, LED: ON when pressing.  
Release pressure at the desired speed.

**3) TO CONTROL PULSATION:**

**1<sup>st</sup> Press:** Slow Pulsation Cycle, LED: ON.

**2<sup>nd</sup> Press:** Quick Pulsation Cycle, LED: Flashes.

**3<sup>rd</sup> Press:** Pulsation Cycle OFF, LED: OFF.



## OPTIONAL HYDROPOOL SURROUND SOUND AUDIO SYSTEM



### INK800 KEYPAD BLUETOOTH AUDIO FUNCTIONS

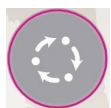
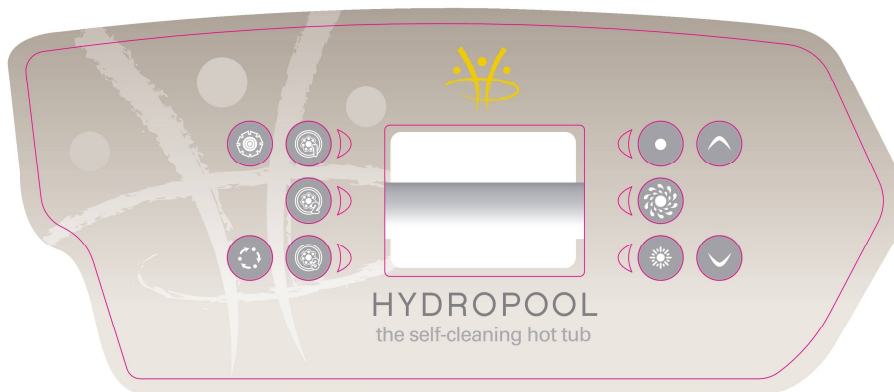

**PRESS YOUR MODE KEY TO ACCESS YOUR IN.STREAM 2 DEVICE**

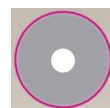

**POWER ON / OFF**



**SOURCE AUDIO DEVICE**



**PLAY / PAUSE AUDIO**



**MUTE AUDIO DEVICE**

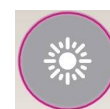

**NEXT TRACK**



**LAST TRACK**

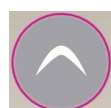

**VOLUME UP / DOWN**

**NOTE:**

If you are using a device with Bluetooth technology, it must be connected for functions to work.

Please note that the "Play/Pause" and "Change Track" functions apply to devices using Bluetooth technology only.

## HOT TUB WATER BALANCE – GENERAL OVERVIEW

### NOTABLE POINTS

- The reliability and longevity of your hot tub support equipment are directly related to how well water quality is maintained!
- The small volume of water in your hot tub is easily affected by the introduction of oils, lotions, perspiration and chemicals. It is imperative that you give your hot tub regular attention to maintain clean, safe and balanced water to prevent premature damage and/or failure (corrosion/calcification) to the support equipment. Maintaining proper hot tub water balance and sanitizer levels is extremely important. Neglected hot water will allow bacteria to quickly spread.
- The mineral content of hot tub water increases due to water evaporation, sanitizers and other chemicals. If the mineral concentration, particularly calcium, becomes too high, the minerals will literally “drop” or precipitate out of the water and deposit on the hot tub walls, plumbing, jets, in the filter and on the heater element.
- It is very important that pH be checked frequently and maintained in the recommended range as indicated in the chart **WATER BALANCE SUMMARY FOR YOUR HOT TUB**
- It is also very important that Total Alkalinity (the ability of the water to resist a change in pH) be maintained in the recommended range as indicated in the chart **WATER BALANCE SUMMARY FOR YOUR HOT TUB**
- Although there may be two identical hot tub models right next door to each other, the maintenance requirements will be different, dependant on such factors as:
  - bather load
  - frequency of use/quantity of bathers
  - different body chemistry
  - sun vs. shade
  - temperature

For these reasons, it is very important to develop proper hot tub water maintenance habits and follow your HydroPool retailer's recommended water maintenance procedures.



**Heater and other component failure due to improper water balance is not covered under warranty.**



### WARNING

#### CHEMICAL HANDLING SAFETY HINTS

- **Never pre-mix chemicals with each other prior to adding to hot tub water.**
- **Add only one chemical to the water at a time.**
- **Always add chemicals to water and not vice-versa.**
- **Chemicals may be corrosive, so handle with care and store in a cool dark place.**
- **Never smoke near chemicals as most are flammable**
- **Ensure any spilled chemicals are carefully cleaned up immediately.**
- **Always have the POISON CONTROL telephone number handy in the event of an emergency.**
- **Keep chemicals out of children's reach**
- **Wear safety glasses and gloves when handling chemicals.**

#### INITIAL WATER FILL & BALANCE

- 1 Make sure the hot tub water is circulating.
- 2 Add a sequesterant (stain and scale controller). Allow water to circulate for an hour before adding anything else to the hot tub water.
- 3 Add a Shock / oxidizing agent .
- 4 Add sanitizing tablets (Bromine or Chlorine) to the dispenser:

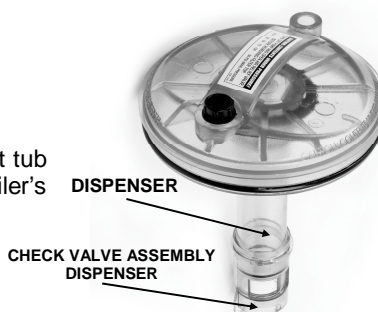

Your HydroPool hot tub comes with a built in bromine/ chlorine dispenser, (located in the lid of the cartridge filter housing), refer to section **CARTRIDGE FILTER** for details on removing and re-installing the lid. Once the filter lid is removed, you'll notice a clear 2.5 cm (1") diameter tube extending from the bottom of the lid.

Expose the large Refill hole at the end of the tube and add 5 or 6 tablets. Do not overfill dispenser as performance will be affected. Turn to expose the largest area and allow water to circulate for 3 or 4 hours before testing level. Adjust to lesser area as necessary to maintain a level of 2 –4 PPM Sanitizer.

Floating dispenser: As above, add 6 or 7 tablets, adjust initially to '5', allow water to circulate for 3 to 4 hours, then test.

The tablets will dissolve slowly over a 10-14 day period, depending on setting, and use of the hot tub.

- 5 Test pH and Total Alkalinity and also adjust accordingly. Expose the large Refill hole at the end of the tube and add 5 or 6 tablets. Do not overfill dispenser as performance will be affected. Turn to expose the largest area and allow water to circulate for 3 to 4 hours before testing level. Adjust to lesser area as necessary to maintain a level of 2-4 PPM Sanitizer.

## GLOSSARY OF COMMON WATER MAINTENANCE TERMS

- 1 **CHLORINE** – in granular, liquid or puck/tablet form, is an oxidant and biocidal agent. It is very effective and fast acting. Recommended chlorine residual level is 3.0 to 5.0 ppm.
- 2 **CHLORAMINES** – a compound formed when chlorine combines with nitrogen or ammonia present in the water. When allowed to go unchecked, it causes eye and skin irritation and is indicated by a strong chlorine odor.
- 3 **ONE-PART BROMINE** – also available in puck/tablet form, is another type of oxidant/biocidal agent, and is introduced into the hot tub water via a brominator. Recommended bromine residual level is 3.0 to 5.0 ppm
- 4 **TWO-PART BROMINE** – composed of a liquid or powder component introduced manually into the water on a weekly basis, and a granular component that is added daily or as the hot tub is used.
- 5 **BROMAMINES** – are formed when bromine destroys nitrogen-bearing organic matter. Unlike chloramines, bromamines don't cause eye irritation, however, when allowed to go unchecked, will cause an objectionable odour.
- 6 **SHOCK** – the practice of adding an oxidizing agent to hot tub water to destroy ammonia, nitrogenous and organic contaminants (chloramines and bromamines)
- 7 **pH** – a logarithmic value expressing the relative acidity or basicity of a substance (such as hot tub water) as indicated by the hydrogen ion concentration. pH is expressed as a number on a scale of 0 to 14, where 0 is most acidic, 1 to 7 being acidic, 7 considered neutral, 7 to 14 being basic, and 14 being most basic. The ideal range for hot tub water is 7.4 to 7.6 ppm
- 8 **pH INCREASER** – raises the pH level of the water.  
**pH DECREASER** – lowers the pH level of the water.
- 10 **TOTAL ALKALINITY (TA)** – the amount of carbonate, bicarbonate and hydroxide compounds present in the water that determines the ability or capacity of the water to resist change in pH. Also known as the 'buffering' capacity.
- 11 **ALKALINITY BOOSTER** – raises the alkalinity.
- 12 **CALCIUM HARDNESS** – the calcium portion of the total alkalinity which represents 70 to 75% of total hardness. Calcium concentrations determine whether water is 'soft' - too little calcium, or 'hard' -too much calcium.
- 13 **CALCIUM BOOSTER** – increases the calcium level.
- 14 **TOTAL DISSOLVED SOLIDS (TDS)** – a measure of the total amount of dissolved matter in the water (calcium, carbonates, bicarbonates, magnesium, metallic compounds, etc.)
- 15 **SEQUESTERANTS (STAIN AND SCALE CONTROLLERS)** – keeps dissolved metals and minerals in the water from attacking the hot tub shell and support equipment components.
- 16 **DEFOAMER** – removes foam build-up from the water surface. At best, this is a temporary remedy, as excessive foam is merely a symptom of improper water balance (typically high organic residue and/or high pH).
- 17 **CARTRIDGE FILTER CLEANER** – degreases and cleans cartridge filters.
- 18 **OZONATOR** – generates Ozone (a gaseous molecule composed of 3 atoms of oxygen) and is injected into the hot tub water for the oxidation of water contaminants.
- 19 **TEST KIT** – used to monitor specific chemical residual or demands in the water. May be in the form of litmus strips or liquid drops.
- 20 **PPM** – abbreviation for 'parts per million', the unit of measurement used in chemical testing which indicates the parts by

### WATER BALANCE SUMMARY FOR YOUR HOT TUB\*

SANITIZER (ppm)	MIN	IDEAL	MAX
Chlorine	1.0	3.0 - 5.0	5.0
Bromine	1.0	3.0 - 5.0	5.0
<b>CHEMICAL</b>			
PH	7.2	7.4 - 7.6	7.8
Total Alkalinity (TA)	80	80 - 120	180
Calcium Hardness	150	200 -400	500 -1000

\*National Spa & Pool Institute recommended levels for residential spas/hot tubs

## WATER BALANCE TROUBLESHOOTING

PROBLEM	POSSIBLE CAUSES	SOLUTIONS
Cloudy Water	Microscopic particles too small to filter out.	Test and adjust all water balance elements and add flocculent* to cause the particles to combine together so they can be filtered out. Increase filter cycle time.
High Total Alkalinity High pH levels High Calcium Hardness		Test these water balance elements and adjust to recommended parameters.
Scale (White/Grayish Deposit)	High Calcium Hardness	Test calcium hardness level and treat with sequestering agent* or perform partial drain/refill.
Skin Eye Irritation	Improper pH and/or Total Alkalinity levels	Test water balance and make the appropriate changes.
Excessive Foam	Buildup of body oils or cosmetics	If no water line is present you can try using defoamer* to break up the contaminants and then a clarifier* to help filter them away. If a water line is present the spa may need to be drained and cleaned. Either way, the filter should be thoroughly cleaned by soaking overnight in bleach. An oil absorbing sponge can help in preventing this in the future. Increase filter cycle time.
	Laundry detergent residual in swimwear	Prevent by running an extra rinse cycle on washing machine or re-rinse well by hand
	Excess organic contaminants	Some organic matter is prone to causing foamy water as it breaks down in the filter (maple leaves especially). Generally using defoamer* to break up the contaminants, then a clarifier*  To help filter them away followed by thoroughly cleaning your filter will clear up the problem. It may however be necessary to drain and refill your spa if the foaming is quite excessive.
	Low Calcium Hardness	Test calcium hardness and if necessary increase with calcium chloride*
Corrosion/Etching	Presence of metals in water (iron, copper, etc)	Test total alkalinity levels and if necessary increase with sodium bicarbonate*
Discoloured Water (Clear v. turbid water)	Presence of metals in water (iron, copper, etc)	Treat with chelating* or sequestering agent*
Unstable pH	Low Total Alkalinity levels	Test total alkalinity levels and if necessary increase with sodium bicarbonate*
pH resistant to changing	High Total Alkalinity levels	Test total alkalinity levels and if necessary decrease with sodium bisulfate* or muriatic acid*
		* Contact your local Hydropool retailer for specific product recommendation

## ROUTINE HOT TUB MAINTENANCE



### REVIEW CHEMICAL HANDLING SAFETY HINTS

#### DAILY

- 1 Test water, and if necessary, add shock.
- 2 Ensure proper water level is maintained.

#### WEEKLY

- 1 Test pH and Alkalinity. Adjust accordingly
- 2 Top-up chemical dispenser
- 3 Add sequesterant (**stain and scale controller**)
- 4 Remove and spray cartridge filter with garden hose and re-install (**see section CARTRIDGE FILTER**)
- 5 Remove and clean out skimmer basket (**see section CLEANING THE SKIMMER BASKET**)
- 6 Add Shock / oxidizing agent
- 7 Inspect union connections for o-ring and gasket leaks - Tighten if loose

#### MONTHLY

Soak your filter cartridge in a filter cartridge cleaning solution. Rinse thoroughly and, if possible, allow to dry before re-installing. HydroPool recommends purchasing a second filter so that while the first is cleaning, the other is clean and ready to install

#### QUARTERLY

Drain hot tub at least once per quarter and clean the acrylic shell surface with a non-abrasive cleaner designed specifically for acrylic surfaces. **See sections CHANGING THE HOT TUB WATER and DRAINING YOUR HOT TUB**



#### CLEANING THE SKIMMER BASKET

- 1 Activate the **STANDBY/DRAIN ASSIST** mode
- 2 Remove the skimmer basket by pulling the weir door forward, and pulling the basket up and towards the front
- 3 Remove debris from basket. (**Note: Avoid hitting the basket against objects to knock debris loose as this may damage the unit**)
- 4 Reinsert basket
- 5 Take the system out of **STANDBY/DRAIN ASSIST** mode, and as the pump begins to operate, monitor water flow over the weir door to assure that it is free floating

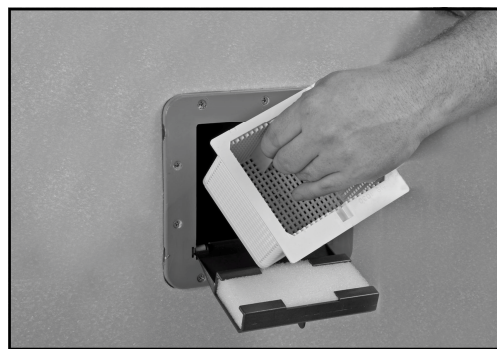

#### SAFETY HARD COVER

When a hot tub is uncovered, over 90% of heat is lost from the water surface. This evaporation also affects the chemical balance and could create humidity problems indoors. HYDROPOOL Safety Hard Covers are engineered for maximum thermal efficiency and appearance. They are hinged in the middle for easier handling, and the zip fastener allows the tapered foam inserts to be changed if damaged. The skirt of the safety hard cover hugs the lip of the hot tub for a tight fit. The handles are placed so that even one person can easily carry a large cover. The locks, with one part fastened to the deck or skirt, prevent small children or animals from entering the hot tub.

Do not drag the safety hard cover across the hot tub or decking. Fold the cover first, then lift by the handles. Standing on the hardcover could cause the tapered foam inserts to crack, which will lead to water absorption.

#### NEVER LEAN OR STAND ON YOUR HARDCOVER.

The cover should be cleaned at least twice a year with a vinyl moisturizer and protector.

**NOTE: ALWAYS ENSURE THE SAFETY HARDCOVER IS IN PLACE AND LOCKED WHENEVER THE HOT TUB IS NOT BEING USED. FAILURE TO DO SO MAY CAUSE DAMAGE OR CRACKING OF THE ACRYLIC SURFACE NOT COVERED UNDER THE WARRANTY.**



## CARTRIDGE FILTER

The cartridge should be cleaned every two to four weeks, depending on the amount of use. Signs that the filter requires cleaning include:

- **Reduced jet power**
- **Hazy gray water**
- **Rattling noise in the pump or filter**
- **Heater not working**

## REMOVAL

- 1 Activate the **STANDBY/DRAIN ASSIST** mode.
- 2 Remove the filter cover and open the small, black air vent / bleeder valve on the top of the filter lid.
- 3 Lift the gray lock tab to disengage and turn the locking ring counter clockwise.
- 4 Pull the filter lid upwards, and lift the cartridge elements straight up and out of filter housing.
- 5 Separate the inner and outer core from each other by pushing the inner core out.

## CLEANING

- 6 With a garden hose and spray nozzle, hose off the cartridge element, ensuring to carefully separate every pleat.
- 7 To remove collected lotions, body oils, etc. soak the cartridge in warm water and a filter cleaning/emulsifying compound (**available at your HYDROPOOL retailer**).
- 8 A cleaning cylinder may be purchased from your HYDROPOOL Hot tub Retailer.
- 9 Rinse thoroughly and dry before replacing.
- 10 HydroPool recommends purchasing a spare filter cartridge so that you always have a clean substitute ready to rotate.
- 11 After the element has dried - if necessary, lightly brush between pleats with a fine paint-brush to remove remaining dirt particles.



**Do not use a wire brush or other device to clean cartridge element. Do not put in dishwasher or washing machine.**

## RE-INSTALLATION

- 12 Place the cartridge filter back into the filter housing.
- 13 Replace the filter housing lid, pushing it down to seat, ensuring that the lid o-ring does not become twisted.
- 14 HydroPool recommends that the lid o-ring be lubricated with a non-petroleum based lubricant (i.e. Silicone gel) when it becomes dry. This will help to prevent twisting and pinching as the lid is installed, and significantly increase longevity of the o-ring.
- 15 Install the filter lock-ring, turning clockwise until the lock tab snaps into place.
- 16 Close the air vent/bleeder valve.
- 17 Take the system out of **STANDBY/DRAIN ASSIST** mode.
- 18 When the pump starts circulating on low speed, it will be necessary to release trapped air in the filter. Carefully loosen the air vent/bleeder valve counter-clockwise until there is the hissing sound of air escaping. Once there is a steady stream of water, close the vent valve, ensuring that the o-ring does not become pinched.

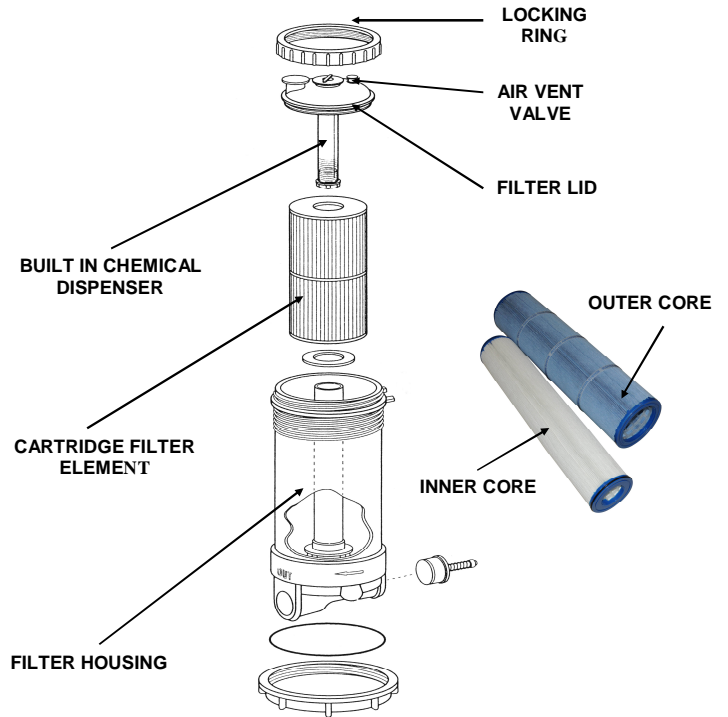

## CLEANING THE ACRYLIC SURFACE

The acrylic surface can be cleaned and polished using a soft cloth and acrylic cleaner, available at your HydroPool retailer.



- **Important: Do not use detergents - the remaining residues will adversely affect water chemistry, making it difficult to maintain proper water balance**
- **Do Not use abrasive cleaners – damage to the acrylic surface will occur.**

## CHANGING THE HOT TUB WATER

A hot tub should be drained every 8-12 weeks, depending on size and amount of use. If your hot tub is used daily or by a large number of bathers, the water should be drained more often. One method to determine the approximate length of time between water changes is to divide the water volume (in liters) of your hot tub by 13.5 and then divide by the average number of bathers each day.

### Formula

$$\left( \frac{\text{Volume of water in liters}}{13.5} \right) \div \left( \frac{\text{Average daily bathers}}{\text{Days between water changes}} \right) = \left( \text{Days between water changes} \right)$$

### EXAMPLE:

1000 liters divided by 13.5 divided by 2 = 37 days. The hot tub water must be changed when the amount of dissolved solids becomes excessive, and is usually indicated by "gray" or dull looking water.

## DRAINING YOUR HOT TUB HYDROPOOL EXCLUSIVE QUICK-DRAIN™ & FILL REFER TO DIAGRAM

### OVERVIEW

- Requires the use of 2 garden hoses - drain hose and fill hose
- While first garden hose is draining old water from hot tub...
- ...second hose is used to wash down interior surface of the hot tub and for fresh water fill.

### REFER TO FIGURE 1 & FIGURE 2

- 1 Locate nearest drain facility (**Check your local bylaws**).
- 2 Put the hot tub control system into **STANDBY/DRAIN ASSIST\*** mode. The system will automatically exit Standby Mode after 1 hour and resume normal operating functions.
- 3 Remove the skimmer basket so that the hole beneath it is accessible, and insert the #10 rubber expansion plug provided.
- 4 Attach garden hose to hose bib located on plumbing line beside the hot tub control system.
- 5 Run garden hose to drain location.
- 6 Open hose bib.
- 7 Close filtration pump return gate valve next to the hose bib (this directs the water out the drain hose).
- 8 Activate the filtration pump.
- 9 Monitor the hot tub while it drains.
- 10 Use the second garden hose to wash down interior surface as the hot tub continues to drain. A sponge may also be used to wipe down the interior surface.

- 11 To completely flush the old water from the plumbing lines: allow fresh water to fill into the foot-well area while the old water continues to be pumped out. Always keep at least 10cm (4 in.) of water in the foot-well so that pump 1 remains primed.
- 12 When the water from the drain hose turns clear (indicating fresh fill water), flush is complete.
- 13 Turn OFF the filtration pump.
- 14 Close the drain-hose bib on the hot tub plumbing line and continue filling hot tub with fresh water.
- 15 Place cover on hot tub (to avoid splash-out).
- 16 Open filtration pump return gate valve.
- 17 Press any button on the topside control panel (other than the pump 1 button) to take the system out of **STANDBY/DRAIN ASSIST\*** mode. Filtration pump and the heater will activate to circulate and heat the water while filling continues. This also reduces the possibility of an airlock occurring.
- 18 Continue adding fresh fill water until level is approximately 19mm (3/4 in.) from the top of the skimmer opening.
- 19 Once fill is complete, remove the #10 rubber expansion plug from the bottom of the skimmer housing.\*\*
- 20 If the filter housing was opened to replace the cartridge filter, it will be necessary to release trapped air from the filter housing by carefully loosening the small black air vent/bleeder valve located on the top of the filter housing. When water begins to escape close the air vent valve.
- 21 In the unlikely event of a pump air lock (pump 1 is operating but there is no water movement from the jets), refer to section **PUMP PRIMING/RELEASING AN AIR LOCK**

\*\* It may be necessary to put system into **STANDBY/DRAIN ASSIST\*** mode in order to remove plug.

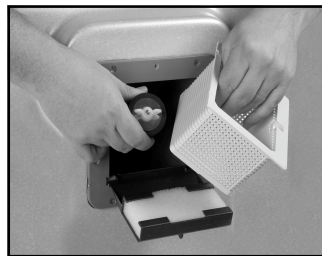

FIGURE 1

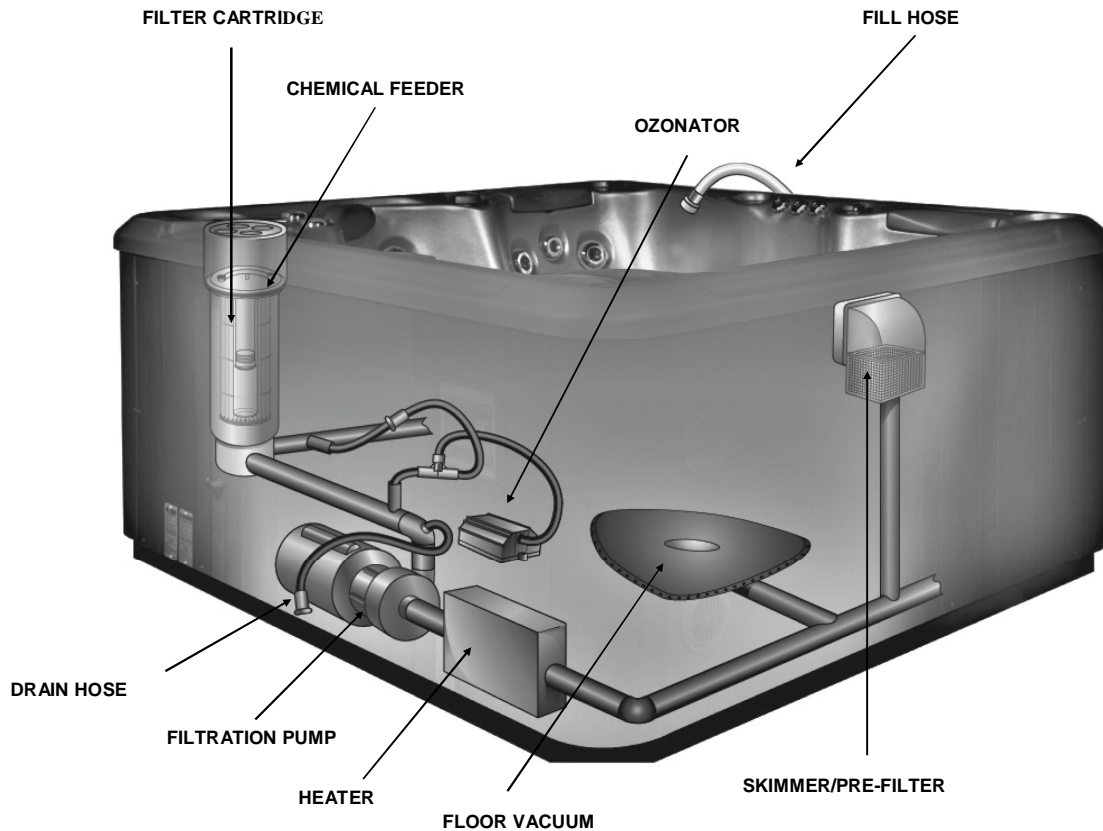

FIGURE 2

## WATER SOFTENERS

Never fill a hot tub with water from a water softener, as it could adversely effect the water chemistry, making it difficult to maintain proper water balance. If you live in an area with hard or soft water, give careful attention to your Calcium Hardness level. Topping up with soft water is acceptable.

## HYDROPOOL EXCLUSIVE QUICK-DRAIN™



### THE SELF-CLEANING MODE INDICATOR

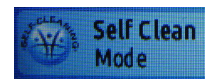

This worry-free indicator is located on the topside control display. The display will indicate “**Self Clean Mode**” on the screen ensuring that the Self-Clean and Eco Heat Systems are both functioning and reassuring you of your family’s safety and protection.

## CABINET WING-LOCKS

The high quality wing-locks provided on your Hydropool Hot Tub cabinet not only firmly secure the equipment access panel, they also serve as convenient handles for removal and replacement. In order to maintain optimum performance and extended life, Hydropool recommends lubricating twice annually with a silicone based lubricant.

**RECOMMENDED PRODUCT: Super-Lube silicone based lubricant (or equivalent) available at major retailers.**



**CAUTION: Do not use a petroleum based lubricant, as this will cause premature deterioration of the lock seal.**

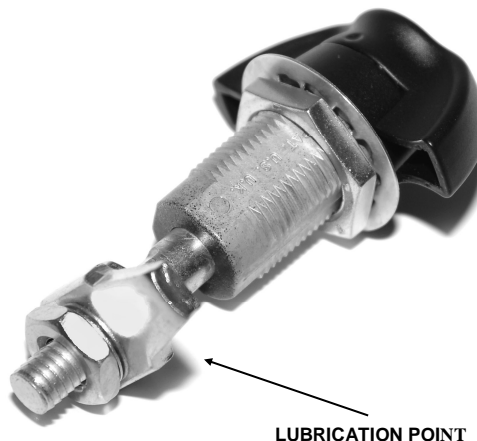

## PROTECTING YOUR CABINET WOOD/ EVERLAST FINISH

Some HYDROPOOL hot tub cabinets are made from Western red cedar and are factory stained. Once stained, cedar weathers well, and with proper care will maintain its beauty for many years. In order to maintain the translucent finish and to enhance the wood grain beauty staining must be performed on a regular basis. These protective finishes stabilize the wood grain and build a durable, breathable water-repellent barrier between the wood surface and the elements. These products are available from your local building supply center..

Some HYDROPOOL hot tub cabinets are made from Everlast synthetic plastic material. These cabinets utilize a magnetic latching system to fasten and hold the exterior panels in place. In order to remove a panel for access you need to start at the lower right hand corner of the panel and disengage the first magnetic latch by pulling the panel forward enough to allow your hand to get behind the panel. Once you have done that you can run your hand behind the panel to disengage the other magnetic latches and be able to remove the panel completely.

To reinstall the panel, line the panel up in the opening and lift it in place and the magnetic latches will engage with the panel so you can shift it place and complete the reinstallation.

HYDROPOOL spa Everlast Synthetic cabinets are made from a unique, non-porous all-weather plastic material and with proper care will maintain its beauty for many years.

### CLEANING

Using hot soapy water and a stiff bristle brush, a soft cloth or sponge will remove surface dirt and grime. Stains can be removed with a water-based cleaner (E.g. Windex, Pledge, Simple Green, etc.). You can also use a power washer with a medium/ wide nozzle setting to clean the surface of the product. Cleaning every few months is recommended.



**...CAUTION: Do not use cleaners containing aromatic solvents or harsh detergent /chemicals on "Everlast" material.**

If dirt and surface contaminants are causing a dirty/brownish tint, an extra step can be taken. Use a 75% bleach and 25% water mixture and wipe the surfaces down. Allow the mixture to remain on the product for an hour, then rinse thoroughly. (Be sure to do this in a safe location and protect your eyes, skin, and wear old clothes).

### MAINTENANCE

Your HYDROPOOL 'Everlast' cabinet is made from a next-generation outdoor premium synthetic material. If the material is damaged during use (scratched or chipped), it can often be repaired.

**Repairing Scratches** — Take a very fine grade of steel wool (0000 grade) and "sand" the scratched area in the same direction that the embossing pattern runs. Apply enough pressure to gradually minimize the scratched area. Once the scratches are reduced, the surface area may appear dull and possibly even lighter in color; however, this will be less noticeable over time and with outdoor exposure. To finish the repair, apply liquid paste such as Finesse-it, furniture polish or

## WINTERIZING YOUR HYDROPOOL HOT TUB

In the event that you do not wish to use your hot tub year-round, it is very important that you properly winterize to protect against damage from freezing. Your HYDROPOOL retailer can perform this service for a nominal fee. If you choose to winterize your hot tub yourself, please follow the directions outlined below:

- Drain the hot tub entirely see section - **DRAINING YOUR HOT TUB**

- Remove and clean the cartridge filter element see section - **CARTRIDGE FILTER**

- Using a wet/dry utility vacuum, remove remaining water from the jet openings, filter cartridge housing, and footwell.
- Either pour or use a turkey-baster where necessary to add potable biodegradable RV antifreeze to areas such as pump wet end, jet channels, filter housing, blower channels.

**DO NOT USE AUTOMOTIVE ANTIFREEZE.**

- **Important:** mixing potable biodegradable RV antifreeze with water significantly reduces its ability to protect against freezing. Therefore, it is very important ALL water is removed from the hot tub plumbing before adding.
- Add potable RV antifreeze to the holes in the bottom suction/drain to prevent any trapped water in the false floor from freezing and damaging the hot tub shell.
- Turn pump on for only a few seconds to circulate the antifreeze.
- Unthread and disconnect all unions in the support equipment area. Remove lowest winter drain plug on pump face plate. Repeat for all pumps, where applicable.

- Cover exposed plumbing connections with plastic bags and duct tape.
- Where practical, disconnect hot tub support equipment and store in a dry heated area.
- Install the safety hardcover, and cover the entire hot tub with a tarp to prevent premature weathering of the cabinet and the safety hard cover.
- Remove snow build up regularly to prevent damage to the safety hard cover.
- It is assumed that your HYDROPOOL hot tub has been properly installed on a reinforced concrete pad to eliminate lifting of the hot tub due to hydrostatic ground water pressure.



**If you are not 100% confident that your hot tub is properly winterized, please consult your authorized HYDROPOOL Hot Tub Retailer. Caution recommends that an authorized Hydropool Retailer winterize your hot tub in the initial year. Damage as a result of freezing is not covered by the warranty.**



**DRAIN PLUG LOCATIONS**

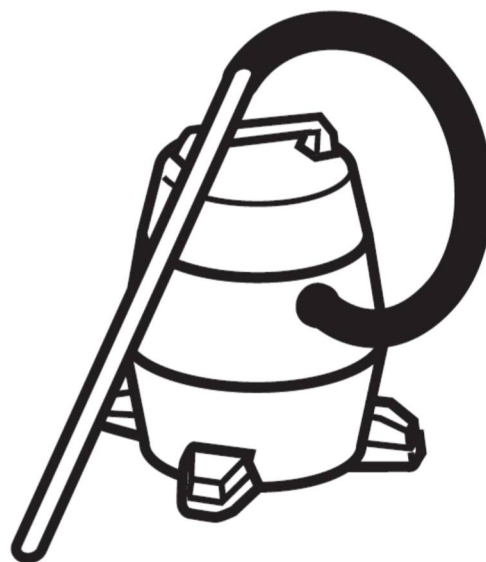

## GENERAL TROUBLESHOOTING

### WHAT TO DO IN THE EVENT OF POWER FLUCTUATIONS

The power supply into your home is, for the most part, fairly consistent.

However, when local power demand is high, there is a tendency for the voltage entering your home to drop (sometimes significantly) or fluctuate.

This condition is referred to as a 'brown-out'. Although safeguards have been built into the system to protect against this condition, supply voltage may drop low enough, if even for a second, to cause the system to display a 'ghost' message. Should this occur or if the display shows partial messages, try resetting the system by turning power to the swim spa, waiting a few minutes, then turning power on again. If this does not reset the system, contact your local HYDROPOOL retailer or service organization.

### POWER FAILURE OR SYSTEM FAULT DURING COLD WEATHER CONDITIONS

If your control system will not reset, (i.e. GFCI trips) or if your pump will not circulate for any other reason, place a low wattage space heater under the cabinet in the equipment area. This will delay the risk of freezing while a service appointment is scheduled.



**Always follow the manufacturers instructions when locating and placing a portable electric space heater into service. Ensure that safe clearance to combustible surfaces is maintained. Do not leave unattended.**

### NOTES:

IN.YE-3 EU WIRING DIAGRAM

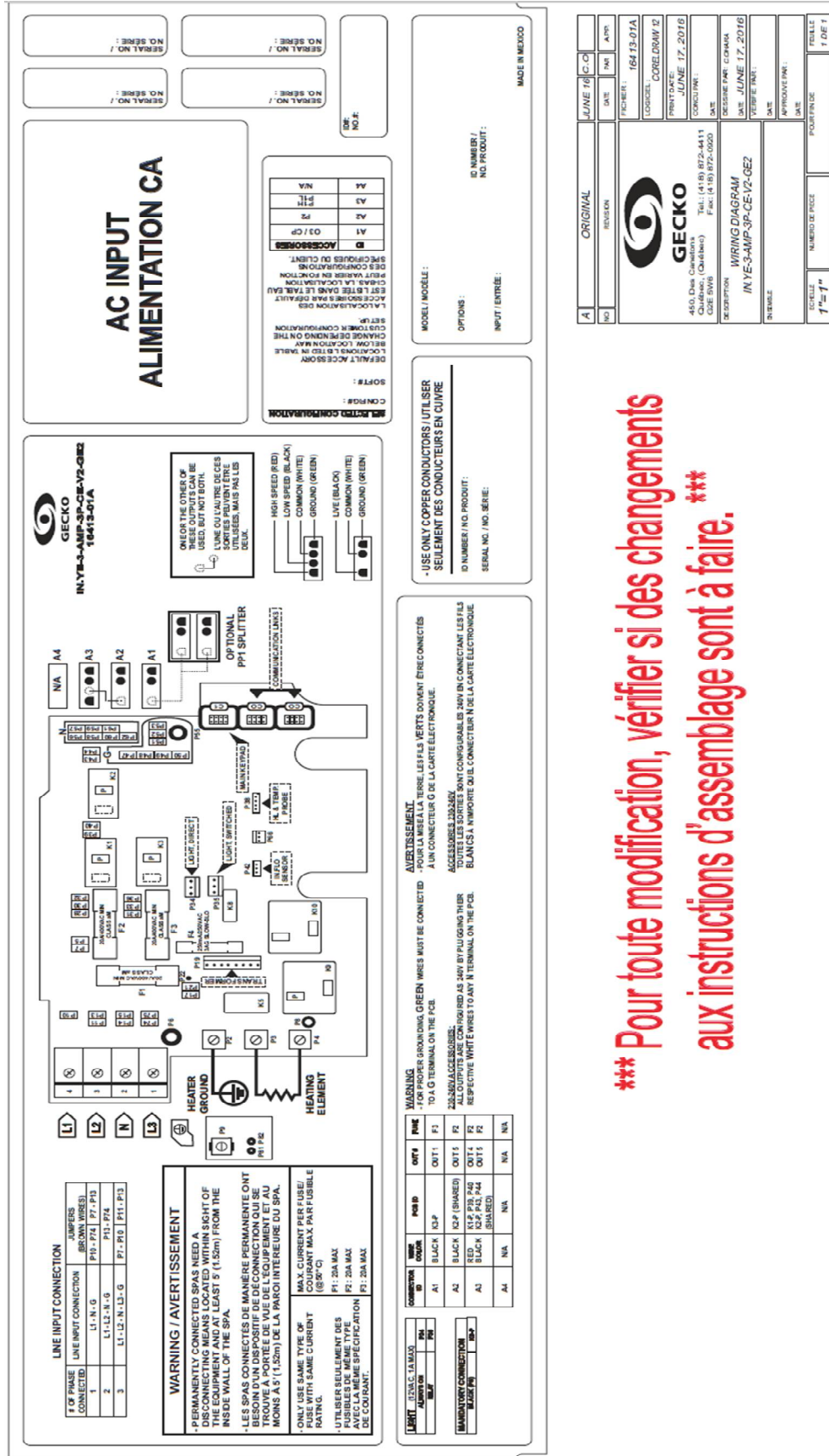

IN.YE-3 NA WIRING DIAGRAM

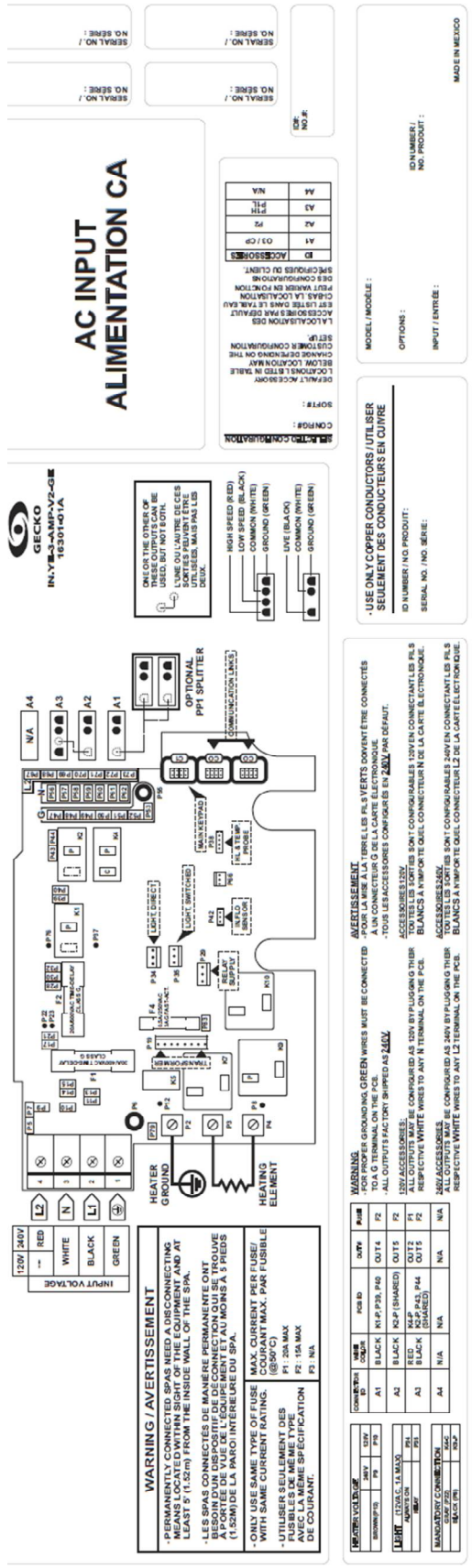

\*\*\* Pour toute modification, vérifier si des changements aux instructions d'assemblage sont à faire. \*\*\*

REV	DESCRIPTION	DATE	BY
A	ORIGINAL	APR 05, 2016	CC
		FIGURE 1: 16301-01A TITRE: CORE DRAW 12 REV: APR 05, 2016 CONÇU PAR: DÉSSINÉ PAR: GOWNA DATE: APR 05, 2016 VÉRIFIÉ PAR: APPROUVÉ PAR: POUR TIRER:	
4610, Des Comptoirs (Canada) 4610, Des Comptoirs (Canada) 4610, Des Comptoirs (Canada) 4610, Des Comptoirs (Canada)		TEL: (416) 972-4811 FAX: (416) 972-0050	
DESCRIPTION: WIRING DIAGRAM IN.YE-3-AMP-V2-GE		DÉSSINÉ PAR: GOWNA DATE: APR 05, 2016 VÉRIFIÉ PAR: APPROUVÉ PAR: POUR TIRER:	



# IN.YE-5 EU WIRING DIAGRAM

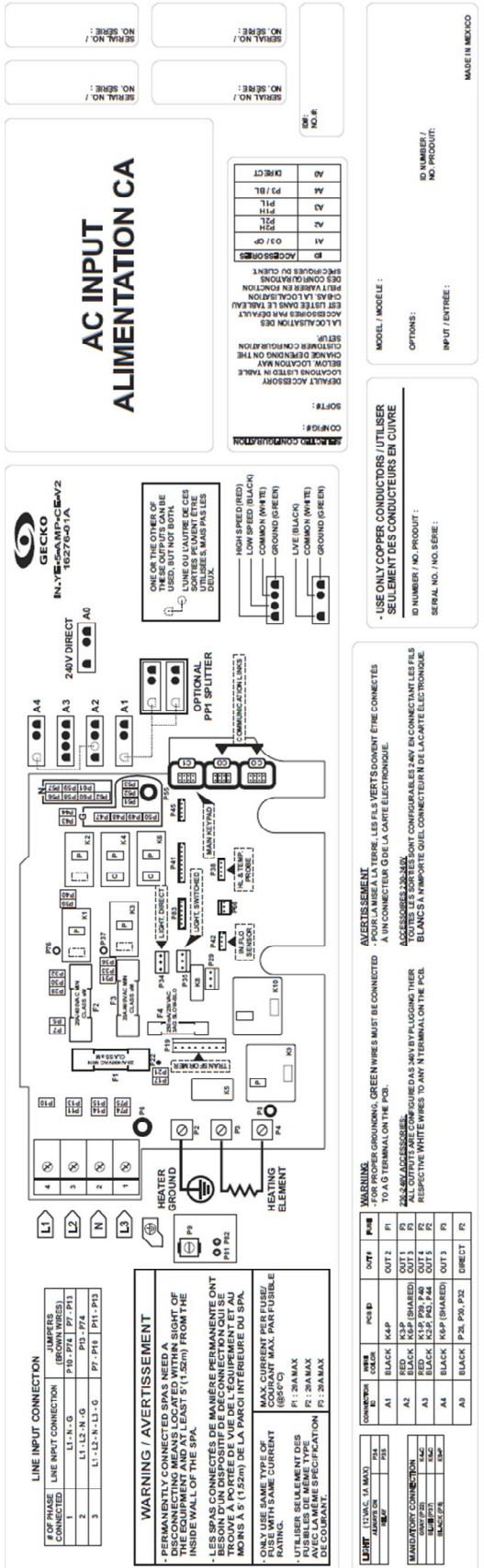

**\*\*\* Pour toute modification, vérifier si des changements aux instructions d'assemblage sont à faire. \*\*\***

ORIGINAL PERSON	MAAR	IB	CC
DATE	DATE	APP	APP
FICHE	16276-01A	CONSEILLER	CONSEILLER
PRENOM	MAAR	DATE	23, 2016
CONJUGÉ		CONJUGÉ	
ADRESSE		ADRESSE	
TELEPHONE		TELEPHONE	
DATE	23, 2016	DATE	23, 2016
VERIFIER PAR:		VERIFIER PAR:	
APPROUVE PAR:		APPROUVE PAR:	
DATE		DATE	
POUR VOUS		POUR VOUS	
NUMERO DE FEUILLE		NUMERO DE FEUILLE	
1 DE 1		1 DE 1	



IN.YT-12 EU WIRING DIAGRAM

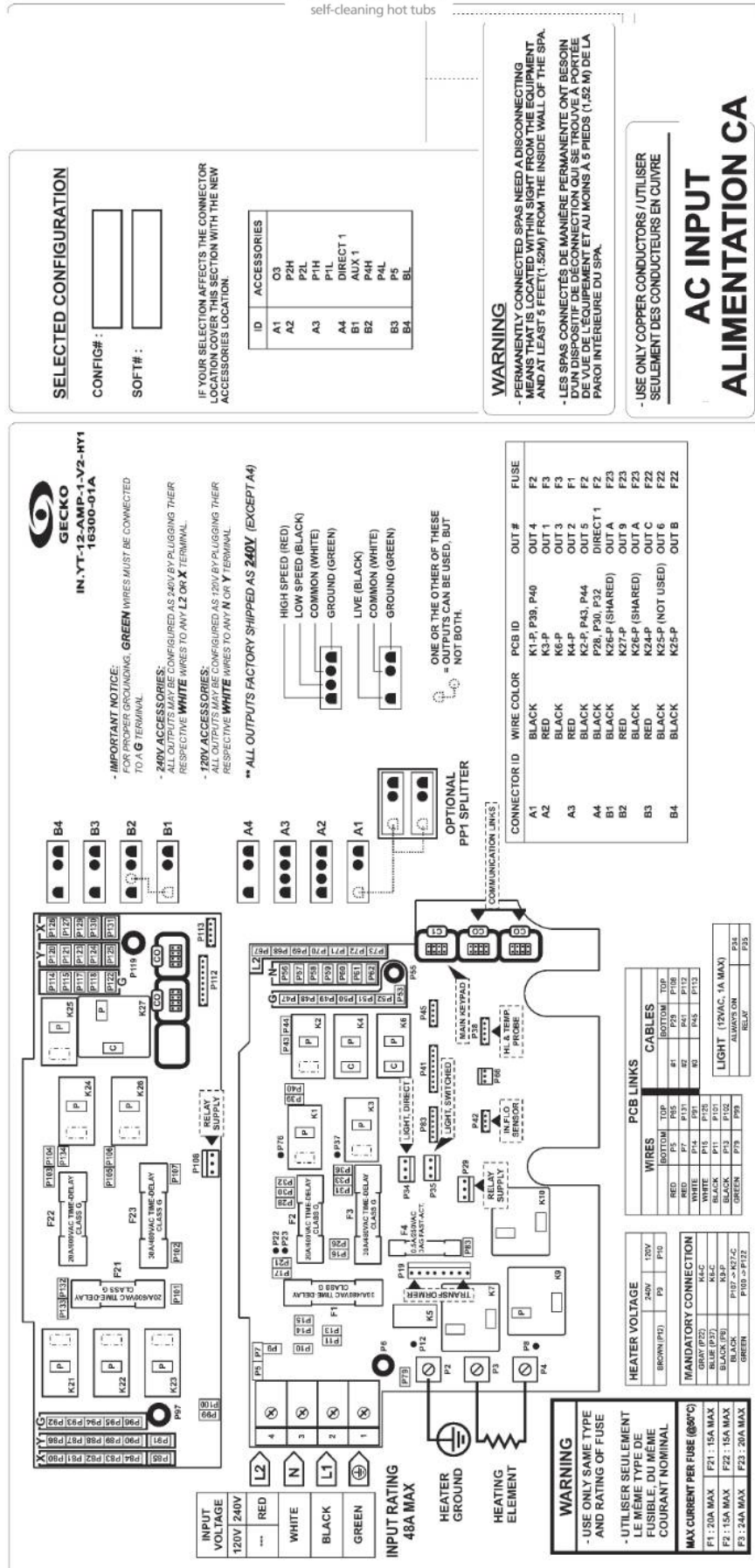

SELECTED CONFIGURATION

CONFIG#:

SOFT#:

IF YOUR SELECTION AFFECTS THE CONNECTOR LOCATION, PLEASE REFER TO THE CONNECTION WITH THE NEW ACCESSORIES LOCATION.

ID	ACCESSORIES
A1	O3
A2	P2H
A3	P1H
A4	DIRECT 1
B1	AUX 1
B2	P4H
B3	P5
B4	BL

WARNING

- PERMANENTLY CONNECTED SPAS NEED A DISCONNECTING MEANS THAT IS LOCATED WITHIN SIGHT FROM THE EQUIPMENT AND AT LEAST 5 FEET (1.52M) FROM THE INSIDE WALL OF THE SPA.  
- LES SPAS CONNECTÉS DE MANIÈRE PERMANENTE ONT BESOIN D'UN DISPOSITIF DE DÉCONNECTATION QUI SE TROUVE À PORTÉE DE VUE DE L'ÉQUIPEMENT ET AU MOINS À 5 PIEDS (1,52 M) DE LA PAROI INTÉRIEURE DU SPA.

- USE ONLY COPPER CONDUCTORS / UTILISER SEULEMENT DES CONDUCTEURS EN CUIVRE

AC INPUT  
ALIMENTATION CA

**GECKO**  
IN.YT-12-AMP-1-V2-HY1  
16300-01A

**IMPORTANT NOTICE:**  
FOR PROPER GROUNDING, GREEN WIRES MUST BE CONNECTED TO A G TERMINAL.

**240V ACCESSORIES:**  
ACCESSORIES CONFIGURED AS 240V BY PLUGGING THEIR RESPECTIVE WHITE WIRES TO ANY L2 OR X TERMINAL.

**120V ACCESSORIES:**  
ACCESSORIES CONFIGURED AS 120V BY PLUGGING THEIR RESPECTIVE WHITE WIRES TO ANY N OR Y TERMINAL.

**\*\* ALL OUTPUTS FACTORY SHIPPED AS 240V (EXCEPT A4)**

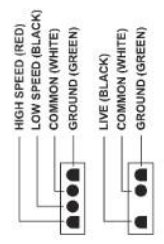

ONE OR THE OTHER OF THESE OUTPUTS CAN BE USED, BUT NOT BOTH.

CONNECTOR ID	WIRE COLOR	PCB ID	OUT #	FUSE
A1	BLACK	K1-P, P39, P40	OUT 4	F2
A2	RED	K3-P	OUT 1	F3
A3	BLACK	K6-P	OUT 3	F3
A4	RED	K4-P	OUT 2	F1
B1	BLACK	K2-P, P43, P44	OUT 5	F2
B2	BLACK	P26, P30, P32	DIRECT 1	F2
B3	BLACK	K26-P (SHARED)	OUT A	F23
B4	RED	K27-P	OUT 9	F23
	BLACK	K26-P (SHARED)	OUT A	F23
	BLACK	K25-P	OUT 6	F22
	BLACK	K25-P	OUT 6	F22
	BLACK	K25-P	OUT B	F22

**PCB LINKS**

WIRES	WIRE #	PCB ID	PCB ID
RED	P18	P18	P18
RED	P7	P131	P131
WHITE	P14	P91	P91
GRAY	P15	P10	P10
BLACK	P13	P102	P102
GREEN	P79	P99	P99

**CABLES**

WIRE #	PCB ID	PCB ID
P1	P21	P112
P2	P45	P112
P3	P45	P112

**LIGHT (12VAC, 1A MAX)**  
ALWAYS ON  
P56  
P56

IN.YT-12 NA WIRING DIA-

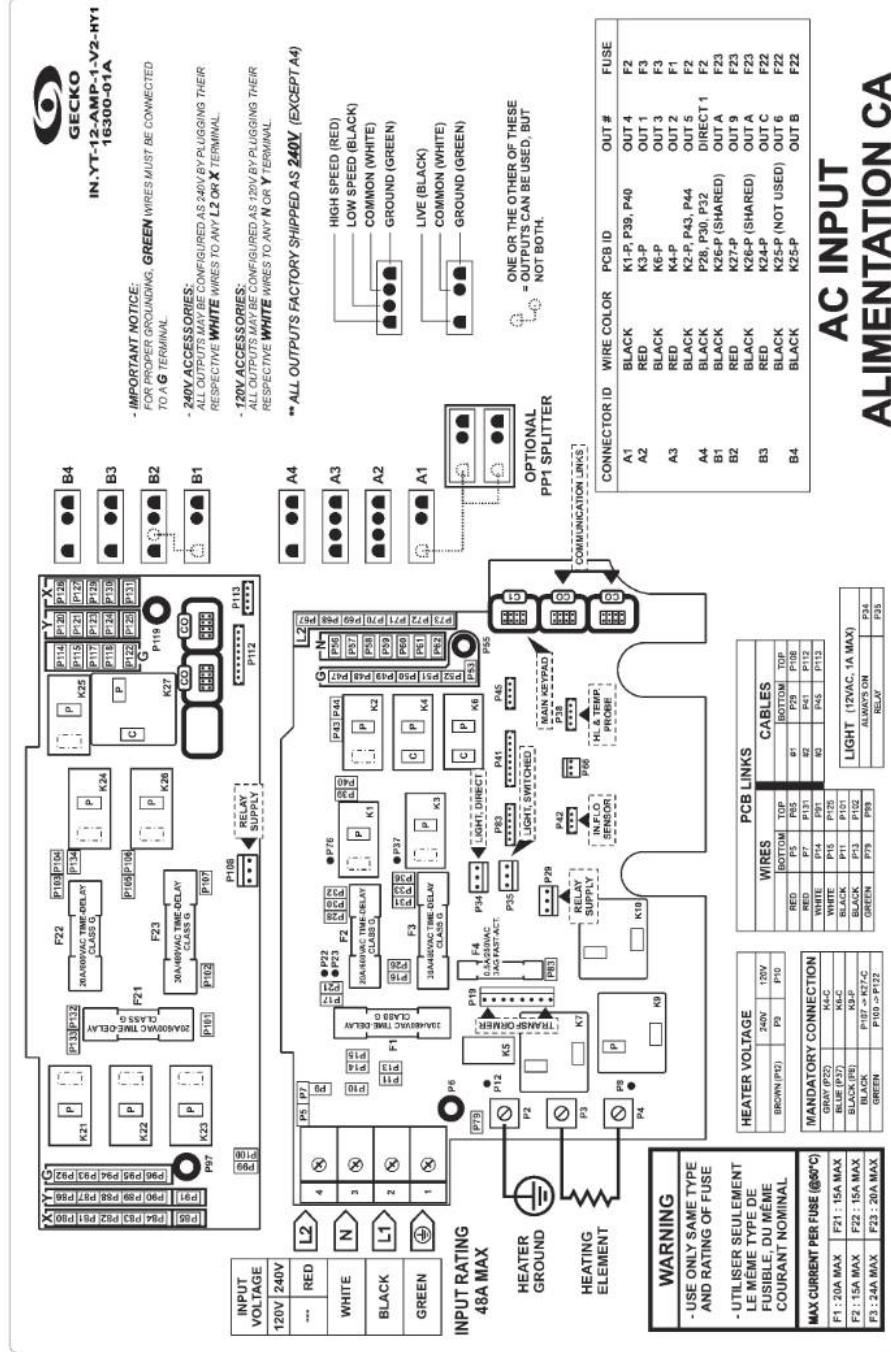

**SELECTED CONFIGURATION**

CONFIG#:

SOFT#:

IF YOUR SELECTION AFFECTS THE CONNECTOR LOCATION, REFER THIS SECTION WITH THE NEW ACCESSORIES LOCATION.

ID	ACCESSORIES
A1	O3
A2	P2H
A3	P2L
A4	P1H
B1	P1L
B2	DIRECT 1
B3	AUX 1
B4	P4H
B5	P4L
B6	P5
B7	BL

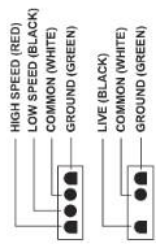

ONE OR THE OTHER OF THESE OUTPUTS CAN BE USED, BUT NOT BOTH.

CONNECTOR ID	WIRE COLOR	PCB ID	OUT #	FUSE
A1	BLACK	K1-P, P39, P40	OUT 4	F2
A2	RED	K6-P	OUT 1	F3
A3	RED	K4-P	OUT 3	F3
A4	BLACK	K2-P, P43, P44	OUT 2	F1
B1	BLACK	P28, P30, P32	OUT 5	F2
B2	BLACK	K28-P (SHARED)	DIRECT 1	F2
B3	RED	K27-P	OUT 9	F23
B4	BLACK	K26-P (SHARED)	OUT A	F23
	RED	K25-P (NOT USED)	OUT C	F22
	BLACK	K24-P	OUT 6	F22
	BLACK	K23-P	OUT B	F22

**AC INPUT ALIMENTATION CA**

**WARNING**

- PERMANENTLY CONNECTED SPAS NEED A DISCONNECTING DEVICE LOCATED WITHIN 5 FEET (1.52M) FROM THE INSIDE WALL OF THE SPA AND AT LEAST 5 FEET (1.52M) FROM THE INSIDE WALL OF THE SPA.

- LES SPAS CONNECTES DE MANIERE PERMANENTE ONT BESOIN D'UN DISPOSITIF DE DECONNEXION QUI SE TROUVE A PORTEE DE VUE DE L'EQUIPEMENT ET AU MOINS A 5 PIEDS (1,52 M) DE LA PAROI INTERIEURE DU SPA.

- USE ONLY COPPER CONDUCTORS / UTILISER SEULEMENT DES CONDUCTEURS EN CUIVRE

**GECKO**  
IN.YT-12-AMP-1-V2-HY1  
16300-01A

**IMPORTANT NOTICE:**  
FOR PROPER GROUNDING, GREEN WIRES MUST BE CONNECTED TO A G TERMINAL.

**240V ACCESSORIES:**  
ALL OUTPUTS MUST BE CONFIGURED AS 240V BY PLUGGING THEIR RESPECTIVE WHITE WIRES TO ANY L2 OR X TERMINAL.

**120V ACCESSORIES:**  
ALL OUTPUTS MUST BE CONFIGURED AS 120V BY PLUGGING THEIR RESPECTIVE WHITE WIRES TO ANY N OR Y TERMINAL.

\*\* ALL OUTPUTS FACTORY SHIPPED AS 240V (EXCEPT A4)